



ADT220 Multifunctional Loop Calibrator

ADT220 Multifunctional Loop Calibrator

————— User Manual

[Version: 201307V01]

Additel Corporation.

STATEMENT

This user manual is applied to Additel 220 Multifunctional Loop Calibrator with the purpose of familiar and correct usage. Information in this document is subject to change without notice.

CONTENTS

1. Welcome to use Additel 220 calibrator.....	1
2. Safety information	2
3. Standard configuration.....	3
4. Cautions.....	4
5. Technical index.....	5
5.1 Working environment	5
5.2 Storage environment	5
5.3 Electrical parameter.....	5
5.4 Technical parameter	5
6. Summarize.....	8
7. Structures and functions	9
7.1 Basic structure.....	9
7.2 Introduction of jack functions.....	10
7.3 Key Functions	11
8. Functions.....	12
8.1 Basic functions.....	12
8.1.1 Calibrator setup.....	12
8.1.2 Measurement functions.....	12
8.1.3 Source functions.....	13
8.1.4 System calibration.....	13

8.2 Utility functions.....	13
8.2.1 As Cal functions.....	13
8.2.2 Statistics functions.....	14
8.2.3 Snapshot storage.....	14
8.2.4 Automatic record functions.....	15
8.2.5 Tools	15
9. Operation.....	16
9.1 Calibrator basic operation.....	16
9.1.1 Common interfaces introduction.....	16
9.1.2 Input method.....	17
9.1.3 Measurement operation.....	17
9.1.4 Source operation.....	18
9.1.5 Hold function.....	22
9.1.6 DC24V power supply status.....	21
9.2 Calibrator setup.....	22
9.2.1 Alarming setup.....	22
9.2.2 Snapshot management.....	22
9.2.3 Records management.....	23
9.2.4 Thermocouple converter.....	23
9.2.5 System setup.....	23
9.2.6 System calibration.....	24
9.2.7 Calculator.....	24

9.2.8 Languages.....	25
9.2.9 Help.....	25
9.3 Measurement.....	26
9.3.1 Current measure.....	26
9.3.2 mV voltage measure.....	27
9.3.3 Voltage measure.....	28
9.3.4 On-off measure.....	28
9.3.5 Loop integrity measure	29
9.4 Source function.....	29
9.4.1 Current source.....	29
9.4.2 Absorbing current.....	30
9.4.3 mV voltage source.....	30
9.4.4 Source voltage.....	31
9.5 Calibration functions.....	32
9.5.1 Measure Calibration.....	32
9.5.2 Source Calibration.....	34
9.5.3 Return to the default value of measure and source calibration data.....	34
9.6 Date statistics function.....	35
9.7 Snapshot saving and management.....	37
9.8 Auto-record function.....	38
9.8.1 New record.....	38
9.8.2 Record view.....	39

9.9 As Cal function.....	40
9.9.1 Loop display device.....	40
9.9.2 As Cal sensor / transmitter.....	43
9.9.3 As Cal signal isolator / converter.....	45
9.9.4 As Cal limit alarm / switch.....	47
Appendix: Additel 220 Communication Commands.....	49-56

1. Welcome to use Additel 220 calibrator

Welcome to use “ Additel 220 Multifunctional Loop Calibrator ” . The calibrator is sturdy and durable with the exquisite figure, high stability and reliability, applying to the on–field industrial calibration and maintenance.

The user manual serves you be familiar with all the functions of “ Additel 220 Multifunctional Loop Calibrator ” . Simple instruction and numerous images let users visually understand their typical applications.

For further information, please visit <http://www.additel.com>, the best calibration solution and the pre–sale & after–sale service will be provided.

2. Safety information

- ◆ Follow all equipment's safety introduction.
- ◆ Do not operate the calibrator around explosive gas, vapor or dust.
- ◆ Do not put battery in the fire or make electricity short circuit. Must use a special adapter to charge, pay attention to recycling of used batteries.

3. Standard configuration

- ◆ Calibrator 1pc.
- ◆ SA10V2A-W adapter 1pc.
- ◆ Li-ion rechargeable battery 1pc.
- ◆ TC150S-4PA test leads 2sets.
- ◆ Special short circuit cable 1set.
- ◆ Users manual 1pc.
- ◆ Electricity test report 1pc.
- ◆ Certificate 1pc.
- ◆ Warranty 1pc.
- ◆ Packing list 1pc.
- ◆ USB/RS232 cable
(suitable for computer connection)

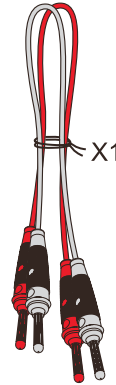

Special short circuit cable

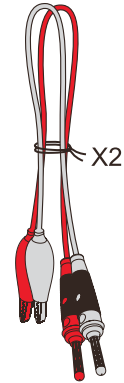

TC150S-4PA test leads

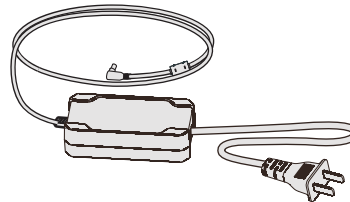

SA10V2A-W adapter

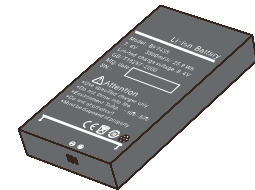

Li-ion rechargeable battery

4. Cautions

Disconnected the test leads before toggle to another measure or source function.

Do not touch the metals parts in the test lead interface to avoid introducing the errors of thermo emf.

Never applying more than 30V between any two electrical jacks (except when 60V voltage is measured).

To avoid water penetration into calibrator, cleaning and maintenance should be executed regularly.

Do not use unspecified adaptor, replace the battery as soon as the battery indicator appears.

Power off the calibrator and take off the battery as soon as calibrator is severely abnormal, contact us immediately.

Do not disassemble the calibrator. Any problem caused by that is beyond our service range.

5. Technical index

5.1 Working environment

- ◆ Temperature: (-10 ~ 50)°C.
- ◆ Relative humidity: < 90%, non-condensation.
- ◆ Atmosphere pressure : (86 ~ 106)kPa.

5.2 Storage environment

- ◆ Temperature: (-20 ~ 60)°C.
- ◆ Humidity: < 90%, non-condensation.

5.3 Electrical parameter

- ◆ Power supply: polymer Li-ion rechargeable battery or adaptor.
- ◆ Charge mode: specified 10V adaptor (charging time less than 4 hours).
- ◆ Battery work: more than 15 hours (the battery icon will flash when the power is low, and the calibrator will be off automatically when it is too low / extremely low).

5.4 Technical parameter

- ◆ Display: 3.5 high resolution and TFT color screen.
- ◆ Size: 192mm × 100mm × 52mm (L × W × H) , weight: 700g.
- ◆ Measure and source: standard Φ 4mm electrical jack.
- ◆ Recharge jack: standard ϕ 2.1mm rechargeable socket.
- ◆ RS232 interface: standard RS232-DB9 socket.

- ◆ RS232 parameter: address 1 ~ 112 optional, baud rate 2400, 4800, 9600, 19200 optional.
- ◆ Real time clock: the order of [Y/M/D] is selectable, and the range of year is 2000~2099, 24 hours.
- ◆ Electrical signal measure specification(working environment $20^{\circ}\text{C} \pm 5^{\circ}\text{C}$, accuracy for one year)

Measure Signal Type	Range	Resolution	Accuracy
mV Voltage	(-300.000 ~ 300.000) mV	1 μV	$\pm (0.01\%RD+0.005\%FS)$
Voltage	(-60.0000 ~ 60.0000) V	0.1 mV	$\pm (0.01\%RD+0.005\%FS)$
Current	(-30.0000 ~ 30.0000) mA	0.1 μA	$\pm (0.01\%RD+0.005\%FS)$
Loop Continuity Test	(0.0 ~ 2000.0) Ω	0.1 Ω	$\pm (0.02\%RD+0.2 \Omega)$
On-Off	If the switch has detective voltage, voltage range: +3V~ +24V.		

Note 1: when working environment is in($-10^{\circ}\text{C} \sim 15^{\circ}\text{C}$ and $25^{\circ}\text{C} \sim 50^{\circ}\text{C}$), temperature parameter is:

- (1) Voltage、current measurement: $\pm (0.001\%RD + 0.0015\%FS) / ^{\circ}\text{C}$.
- (2) Loop continuity test: $\pm (0.002\%RD + 0.001\%FS) / ^{\circ}\text{C}$.

Note 2: Input features:

- (1) Voltage measurement: input impedance $>1\text{M}\Omega$, the highest input voltage of ports $\pm 300\text{VDC}$.
- (2) Current measurement: input impedance $<10\Omega$, the highest input current of ports $\pm 1\text{ADC}$.
- (3) Loop continuity test: the measurement current 0.58mA, the highest input voltage of ports DC $\pm 30\text{V}$.

◆ Electrical signal source specification(working environment $20^{\circ}\text{C} \pm 5^{\circ}\text{C}$, accuracy for one year)

Source Signal Type	Range	Resolution	Accuracy
mV Voltage	(-10.00~200.00)mV	0.01mV	$\pm (0.02\%RD+0.005\%FS)$
Voltage	(0.000 ~ 12.000) V	1mV	$\pm (0.02\%RD+0.005\%FS)$
Current	(0 ~ 22.000) mA	1 μ A	$\pm (0.02\%RD+0.005\%FS)$
DC24V	N/A	N/A	24V \pm 0.5V

Note 1: when working environment is in($-10^{\circ}\text{C} \sim 15^{\circ}\text{C}$ and $25^{\circ}\text{C} \sim 50^{\circ}\text{C}$), temperature parameter is:

(1) Voltage、current source: $\pm (0.001\%RD + 0.0015\%FS) / ^{\circ}\text{C}$.

Note 2: source features:

(1) mV voltage source: load capability 1mA, load variance ratio 50 μ V/mA.

(2) 12V source: load capability 5mA, load variance ratio <1mV/mA.

(3) Current sources: internal power supply, load capability 20mA@1k Ω .

External power supply, voltage: (0-36) V.

The biggest load capability: sourcing current \times sourcing resistance < (supplied voltage-4) V.

(4) DC24V source: the biggest load-bearing capability 50mA, source ripple wave <50mV.

(5) All ports contain short circuit protection function.

(6) The highest voltage range of all the sourcing ports: $\pm 30\text{VDC}$ (less than 1 minute duration), the gauge will be damaged when exceed this range.

6. Summarize

The Additel 220 Multifunctional Loop Calibrator gather current measurement / output, voltage measurement / output, loop continuity test and switch capture and other functions into one, and all the circuit devices to meet the on-site calibration and repair work needs. In order to improve user productivity, it provides a powerful As Cal features that make the calibration workflow, paperless, simplified, graphical, and for specific needs, it also provides functions of measurement data statistics, the snapshot and storage time.

Main Features:

1. Measure current, voltage, on/off (switch), loop continuity test, output current and voltage signals.
2. To measure and source simultaneously and isolated from each other.
3. Providing DC24V power supply, and be isolated from measurement and sourcing.
4. Supporting 25%, 100%, auto-stepping and auto-ramping source mode.
5. Providing strong As Cal function.
6. Perfect measurement data statistics.
7. Convenient screen snapping and management functions.
8. Supporting screen data automatic record.
9. Supporting on-line firmware upgrading.
10. High resolution TFT display screen, excellent user interface, optional Chinese / English version.
11. The size and weight are the same with common multi-meter, hand-held and easily use.

7. Structures and Functions

7.1 Basic structure



Figure 7.1 Basic structure





















7.2 Introduction of jack functions

Sheet7-1

Jack	Introduction
2, 7	①Voltage measure. ②mV voltage measure. ③on/off measure. ④Loop continuity test: 2 positive, 7 negative.
1, 7	Current measure: 1 positive, 7 negative.
1, 8	AR transmitter sample resistance: 250 .
3, 6	①Voltage source. ②mV voltage source. ③Current simulate mA.
3, 4	Current source, (internal power supply 24V) 4 port of current source.
4, 5	DC24V source: 4 positive, 5 negative.
RS232 port	Jack for connecting PC.
Rechargeable jack	Charging.

7.3 Key Functions (7-2)

Sheet7-2

NO	Key	Instruction
1		Switch key: power on/off.
2		Toggle key: current measurement, mV voltage measurement, voltage measurement, switch capture, loop continuity test.
3		oggle key: current measurement, mV voltage and voltage measurement data statistics. View the switch captured data.
4		Zero Measurement data.
5		Toggle key: current source, current Simulate mA, mV voltage source, voltage source.
6		Toggle key: span output in accordance with source range.
7		Toggle key: span output in accordance with 25% source range.
8		Toggle key: start calibrator As Cal function, view detail in 9.9 chapter.
9		Shortcut key: selects the setup interface.
10		Shortcut key: snapshot saving.
11		Shortcut key: exits the present menu or returns to the original menu.
12		Shortcut key: completes or confirms an operation、 Hold function key.
13		Navikey: up, down, left, right, calculator, +、-、\、/
14	Softkeys	 F1 、  F2 、  F3 、  F4 .
15	Numeric	 0 ~  9 、  $\frac{\square}{\square}$ 、  .

8. Functions

In order to make user know about the functions of calibrator soon, we put them into two kinds:

Basic functions: calibrator setup, measurement function, source function, calibration function.

Utility functions: As Cal, statistics, snapshot, timing and storage, common tools.

8.1 Basic functions

8.1.1 Calibrator setup

1. Serial ports: sets the address of serial ports (1-121) and Baud rate (2400, 4800, 9600, 19200). Please refer to the addenda commands of Additel 220.
2. Date and time: 【 Year / Month / Day Hour: Minute 】 , the range of year is 2000~2099. 24 hours.
3. Screen: adjustment the lightness and backlight.
4. DC24V Power: turn on/off 24V power.
5. Language: Chinese and English.
6. Hardware update: update through serial port is available.
7. Power off: set the automatic power-off.
8. Restore factory settings: restore the state of original setting.

8.1.2 Measurement functions

1. Current: DC 0mA.
2. mV Voltage: DC 00mV.
3. Voltage: DC 0V.

4. On / off: realizes the switch function and records the trigger data.
5. Loop continuity test: two-wire resistance measurement (0~2000) Ω , threshold can be set (default: 100 Ω).

8.1.3 Source functions

1. Current source: range (0~22) mA, supporting 25%, 100%, auto-stepping, auto-ramping and keyboard setting source mode.
2. Current simulate mA: range (0~22) mA, supporting 25%, 100%, auto-stepping, auto-ramping and keyboard setting source mode.
3. mV voltage source: range (0~200) mV, supporting 25%, 100%, auto-stepping, auto-ramping and keyboard setting source mode.
4. Voltage source: range (0~12) V supporting 25%, 100%, auto-stepping, auto-ramping and keyboard setting source mode.
5. DC24V: supply the power.

8.1.4 System calibration

1. Measurement items calibration: current (30mA), voltage (300mV、 60V), loop continuity.
2. Source items calibration: current (22mA), voltage (200mV、 12V).

8.2 Utility functions

8.2.1 As Cal functions

The calibrator built-in 4 on-site calibration tools, loop indicator, transducer / transmitter, signal isolator / converter, and limit alarm / switch.

1. Loop indicator: calibrate the on-site digital device and pointer device with the display value basis.
2. Transducer / transmitter: calibrate the on-site current or voltage source transmitter.

3. Signal isolator / converter: calibrate all kinds of on-site secondary instrument such as isolator with automatic calibration.
4. Limit alarm / switch: calibrate all kinds of on-site switch controller and alarm with switch capture calibration.

The calibration process is simple, can greatly improve the efficiency. The calibration point error can be display by curve /data in real time. The calibration can automatically calculate the maximum error after calibration. Calibration data can be stored in snapshot feature.

8.2.2 Statistics functions

Powerful data analysis capabilities that can display the maximum, minimum, peak, average and percentage. The measurement data can be migrated also can change measurement data into the actual physical data by using the scaling feature.

1. Maximum, minimum, peak, average: routine data analysis.
2. Data tare: to change the steady data into zero.
3. Scaling: according to the linear or flow relation, Additel 220 can transfer the output signals of the tested gauge into real physics value, such as (0-100) kPa.
4. Supporting the statistics data display.

8.2.3 Snapshot storage

The calibrator provides an easy way to save data. When in measure, source function, press  all the present parameters of source and measure can be saved as a storage record. This is called Snapshot storage. The calibrator can save a maximum of 100 records.

Every record has its own number (automatically numbered or by user). These records can be view, upload or delete. However, they are not available to edit.

8.2.4 Automatic record functions

Calibrator provides automatic recording function. It can record a series of measurements and upload them to a compatible host computer. Calibrator can record up to 20,000 data. Each time stored data depends on the reading section interval, duration, and the remaining storage space. These records can be viewed online. Index analysis, automatic drawing curves or list, or you can delete them one by one or delete all.





8.2.5 Tools

1. Hold function: lock screen function.
2. Thermocouple conversion: support thermocouple temperature and electrical signals exchange, meeting international temperature scale ITS90.
3. Calculator: supporting simple calculate.
4. Help: provides help information of overview of calibrator, characteristics, measurement, and output, As Cal, snapshots, record, and system calibration.

9. Operation

9.1 Calibrator basic operation

9.1.1 Common interfaces introduction

1. Main interface: press  to start up and go into the main interface (Figure 9.1). At the top of screen is measure and below is source.
2. System set-up interface: press  to the set-up interface (Figure 9.2). In this interface, press  or  and return to the main interface.

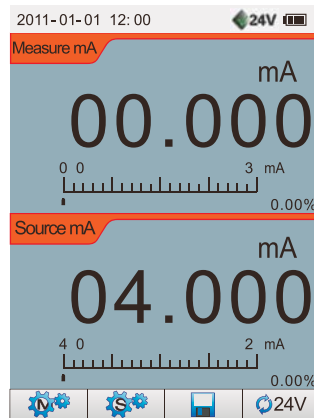

Figure 9.1 Main interface

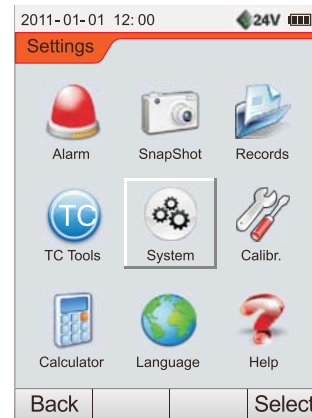

Figure 9.2 Setting interface

9.1.2 Input method

1. Numerical input: use numerical keys 0 ~ 9、 $\frac{1}{x}$ 、 \bullet to input any numbers. User can use \leftarrow to backspace or \rightarrow to invert.

2. Characters input: introduction of ABC keyboard input method.

Introduction of ABC keyboard input method :

a) Supporting ABC keyboard input method, capital letter, lowercase and numbers are available.

b) Use \leftarrow $\left[\begin{smallmatrix} + \\ - \end{smallmatrix} \right]$ \rightarrow to choose the required characters, press $\left[\begin{smallmatrix} \text{Enter} \\ \text{Hold} \end{smallmatrix} \right]$ to confirm.

c) Use numerical keys 0 ~ 9、 $\frac{1}{x}$ 、 \bullet to input any numbers.

d) Use $\left[\text{F3} \right]$ backspace the input.

e) Press $\left[\text{F4} \right]$ to complete the string input.

9.1.3 Measurement operation

In the main interface, press key $\left[\text{Meas} \right]$ in the measurement pop-up option (Figure 9.3), use $\left[\uparrow \right]$ 、 $\left[\downarrow \right]$ key to switch between different items, after that, press the key $\left[\text{F1} \right]$ into the range / resolution setting interface, user can change the scale display as per the range of gauge under test, or set the display resolution.

In the main interface, user can press $\left[\text{Stat} \right]$ to start the statistics function of measure data. Details please refer to chapter 9.6.

In the main interface, user can press $\left[\text{zero} \right]$ to zero the measure data.

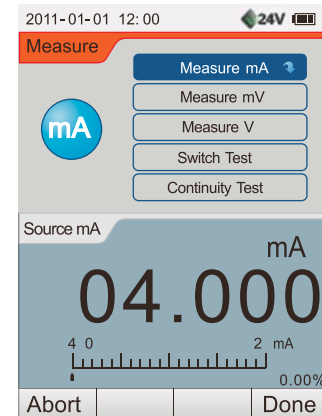

Figure 9.3 Switch in measure items

9.1.4 Source operation

In the main interface, press the key **Source** pop-up option (Figure 9.4), use **↑**、**↓** key to switch between different output items. After that user can change the output value by the following ways :

1. Use **25%** to **100%** change the source mode

a) Linear relationship source mode ,

Press the key **25%** to output 5% of the scale source range linear stepping.

Press the key **100%** to span output switching from 0% to 100% of scale source range.

b) Flow source mode ,

Press key **25%** to flow stepping source by 0%, 25%, 50%, 75%, 100% of scale source range.

Press the key **100%** to span output switching from 0% to 100% of scale source range.

c) Valve position source mode ,

Press the key **25%** to source one by one as per the setting points.

Press **100%** to span source by switching from the minimum and maximum as per the setting point.

2. Use keyboard numbers to set up output

In the main interface, press numerical keys **0 ~ 9**、**±**、**•** , an input box will be popped in source zone, and numbers

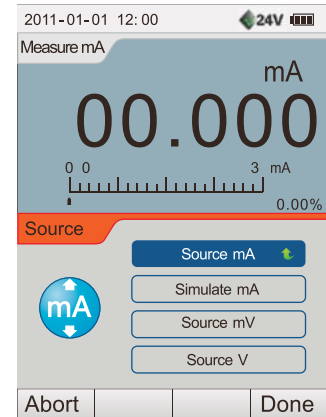

Figure 9.4 Switch in source items

can be input continuously, then press **F4** or **Enter Hold** to finish the setting of output :

a) When input, user can press **F1** or **Esc** to exit.

b) If user does not input again within 15 seconds, the calibrator will abandon this input. The input is invalid.

c) The calibrator will judge whether the input is valid or not. Any input that exceeds the output range will be abandoned.

3. Keyboard source in fine adjustment

In main interface, press **←** or **→** to fine adjustment status: there is a cursor under the last number of the output, in which the value can be edited:

a) Use **←** or **→** to move the cursor.

b) Two ways to edit the value in the cursor :

① Use **↑**、**↓** to edit.

② Use numerical keys **0** ~ **9** to edit.

c) The value will be going into effect after it is edited.

d) Press **Enter Hold** or other functional keys to exit fine adjustment.

e) If there is no any change in the output within 15 seconds, it will exit fine adjustment.

4. Stepping source

a) Enter the automatic source list, and select the option to Auto-stepping, press **F4** or **Enter Hold** to enter the parameter setting interface.

b) According to stepping source mode, stepping parameter setting can be divided into two categories, one is linear or flow source mode and the other is the valve position source mode.

1) Linear or flow source mode:

- ① Enter the single-step time: interval between two step points, the value (1 ~ 3600) s.
- ② Enter the starting value of step (V_s) and end value (V_e), must satisfy ($V_s < V_e$).
- ③ According to the choice of the step model to confirm the value of each stepping points, as shown in Table 9-1:

Sheet 9-1

	Linear	Flow	Commentary
Percentage	$V_s + (V_e - V_s) * (n-1) * P\%$, $n = 1, 2, \dots; (n-1) * P\% \leq 1$	$V_s + (V_e - V_s) * (n-1) * (P\%)^2$, $n = 1, 2, \dots; (n-1) * P\% \leq 1$	P is the step of Percentage
Stepping points	$V_s + (n-1) * E$, $n = 1, 2, \dots; (n-1) * E \leq V_e$	$V_s + (n-1) * E$, $n = 1, 2, \dots; (n-1) * E \leq V_e$	E is Step of engineering unit
Engineering units	$V_s + (n-1) * (V_e - V_s) / (N - 1)$, $n = 1, 2, \dots; (n-1) \leq N-1$	$V_s + (V_e - V_s) * [(n-1) / (N - 1)]^2$, $n = 1, 2, \dots; (n-1) \leq N-1$	N is Step of step Number

- ④ Operating modes: single operation, repeat operation.

2) Valve position source mode:

- ① Enter the single-step time: interval between two step points, the value (1 ~ 3600) s.
- ② Location of valve testing: low end, setting end or high end.
 - i) Low end: contain the test point 1 to test point 3.
 - ii) Setting end: contain the test point 1 to test point 7.
 - iii) High-end end: contain the test point 5 to test point 7.

③ All test points can be manually modified using the key **F3** to set the system default value.

Note: the default value of the system are: 3.8, 4, 4.2, 12, 19, 20, and 21.

c) After parameter setting, press key **F4** or **Enter Hold** to enter the main interface.

d) Select start key **F4**, source automatic one by one according to each setting stepping point, providing function of stop, pause, and continue.

5. Ramping source

a) Enter the automatic source list, select the option to auto-ramping, press **F4** or **Enter Hold** to enter the ramping parameter setting interface.

b) Input the ramping parameter:

① Enter initial value of ramping (V_s) and end value (V_e), must satisfy ($V_s < V_e$).

② Enter the ramping interval(T): time for $V_s \rightarrow V_e \rightarrow V_s$, the longer of the time required, the smaller of the source change, the value (1 ~ 3600) s.

③ Operating modes: single operation, repeat operation.

④ According to the input, V_s , V_e and T to confirm the gradient of ramping: $(V_e - V_s)/(k \cdot T/2)$. Hereinto: $k = 25$, system settings.

c) After ramping parameter setting, press **F4** or **Enter Hold** to the ramping output main interface.

d) Press **F4** to start. The calibrator will automatically output base on the setting ramping grads and provides functions to pause and continue.

9.1.5 Hold function

Calibrator provides Hold function, in the main interface, stepping and ramping source, user can use this feature. Please be noted, in the step and ramp source using Hold function, the interface is just to stop the refresh, and real source will continue in the background.



9.1.6 DC24V power supply status

In the main interface, press **F4** key to cycle switch the DC24V power state: closed, open, and loop power supply. When DC24V power supply is turned off, the battery operating time can be increased. After setting, the calibrator will automatically memorize the setting status, even power off.

To calibrate the current transmitter easily, the calibrator will make short circuit for the current measurement negative terminal with the DC24V negative terminal in the states of Loop power and the DC24V has been on.

Note: the power states of the DV24V only have two types (on and loop power) when the output item is set as current output.

9.2 Calibrator setup

In the main interface, press **Setup** to enter the calibrator setup interface, totally nine choices. Use  to toggle between different items. Press **F4** or  to enter the relevant setup items, or press **1 ~ 9** to enter relevant setup items.

9.2.1 Alarming setup

The audible alarming of the exceed measurement range can be selected. And this setting will be auto-remembered by the calibrator even remove the power.

9.2.2 Snapshot management

The calibrator can manage, view and delete snapshot files and the name of snapshot saving record can be edited. Please

refer to chapter 9.6.

9.2.3 Records management

The calibrator can view and delete the automatic recording files. It also can setup the label, the reading as well as the duration of the records and providing the relevant storage information. Please refer to chapter 9.8.

9.2.4 Thermocouple converter

Thermocouple (RSBKNEJT) conversion, cold junction temperature can be modified, you can use three kinds of temperature units (°C, °F , K), the temperature value and power value of the refresh synchronization.

9.2.5 System setup

There are six setups for this interface, namely the clock setup, screen setup, automatic shutdown setup, communication setup, hardware upgrade and restore the factory setup.

1. Clock setup

In this interface, time and date and the date format can be set. When the input exceed the allowed range, the calibrator will automatically change into the nearest allowed number. The calibrator provides the rationality examination function of month and date, leap year and leap month.

2. Screen setup

User can set the screen brightness and set up the closing time of indicator backlight display. There are 11 grades to choose for the screen brightness. The higher of the percentage, the screen will be brighter. In this interface, user can choose the function of turning of the backlight when there is no keyboard operation. There are five selections of backlight time, which are: never, five minutes, 10 minutes, 30 minutes and one hour. These settings will be remembered by the

calibrator even remove the battery.

3. Shutdown setup

In order to avoid unnecessary battery consumption, the calibrator provides the function of automatically shut down when there is no any keyboard operation. The calibrator also provides four kinds automatically shutdown, including never shutdown, after 30 minutes, one hour, and two hour. These setting will be remembered by the calibrator even remove the battery.

4. Communication setup

Communicate with the PC through RS232: selectable parameters : address (1~121) and the baud rate (2400,4800,9600,19200).

5. Hardware upgrade

Built-in software code of the loop calibrator upgrade is available.

Important Notice: please do the necessary preparing works and assure the operation is correct and continuous if you upgrade hardware. Otherwise, the calibrator cannot be startup and work normally.

6. Restore factory setup

The calibrator can restore to the factory setting. The password is 312.

9.2.6 System calibration

To calibrate the calibrator, please refer chapter 9.5.

9.2.7 Calculator

Calibrator provides calculator.

9.2.8 Languages

User can toggle to Chinese or English interface instantly without restarting. The setting will be remembered even remove the battery.

9.2.9 Help

In this interface, there are summary, features, specification, basic connection figures and classical application.

1. Summary

User can use this as a reference to know the summary of the main functions of calibrator.

2. Features

It points out the features of the calibrator.

3. Measurement function

Wiring diagram: shows the measured signal, the transmitter and the HART transmitter measurement wiring diagram.

Statistics: statistical functions are given the help instructions.

4. Source function

Wiring diagram: show the source signal output and the wiring diagram of the 24V power.

Ramping source: show the setup of the auto-ramping output parameters and help instruction of the ramping source interface.

Stepping source: show the setup of stepping source output parameters and help instruction of the stepping source interface.

Valve source: show setup of the valve parameters and help instruction of the valve output interface.

5. As Cal

Calibration circuit indicator: show wiring, curve display and help instruction of the data display for the calibration circuit indicator.

Calibration of the sensor/transmitter: show wiring, curve display and help instruction of data display for calibration the sensor/transmitter.

Calibration signal isolator/converter: show wiring, curve display and help instruction of data display for calibration signal isolation/converter.

Calibration limit alarm/switch: show wiring, curve display and help instruction of data display for calibration limit alarm/switch.

6. Snapshot function

Show the help instruction of the snapshot.



7. Record function

Show the help instruction of the records.

8. System calibration

Show the wiring diagram of the calibrator.

9.3 Measurement

Refer to measurement items options (Figure 9.3), use  、  key to switch the calibrator 5 measurement functions: current, mV voltage, voltage, on-off capture and circuit loop test.

9.3.1 Current measure

1. Refer to Figure 9.5 to connect test leads and begin to measure.
2. Before test, user can press **zero** to ZERO the measure value in short circuit.

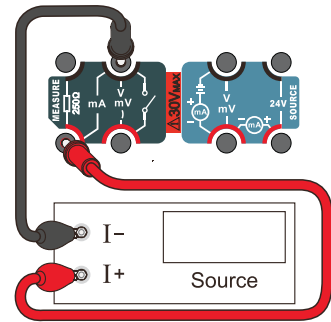

Figure 9.5 Current measure

3. The ruler display and the display resolution can be changed according to the range of the tested instruments :

- 1) Press **F1** to enter the scale range setting interface, as shown in Figure 9.6.
- 2) Press **↑**、**↓** key to select the scale range.
- 3) Press **←**、**→** key switch to the resolution settings screen, select the appropriate display digits.
- 4) Press **F4** or **Enter/ Hold** key to complete the set.

9.3.2 mV voltage measure

1. Switch to the mV voltage measurement function, as shown in Figure 9.7 Connect the test line.
2. Before test, user can press **zero** to ZERO the measure value in short circuit.
3. The ruler display and the display resolution can be changed according to the range of the tested instruments :

- 1) Press **F1** to enter the scale range setting interface, as shown in Figure 9.6.
- 2) Press **↑**、**↓** key to select the scale range.
- 3) Press **←**、**→** key switch to the resolution settings screen, select the appropriate display digits.

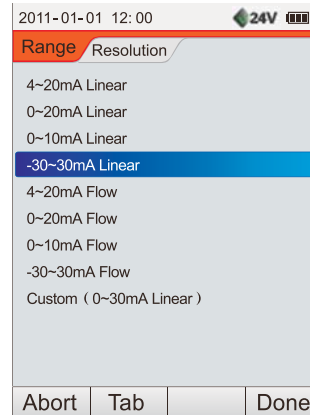

Figure 9.6 Setup of current measure

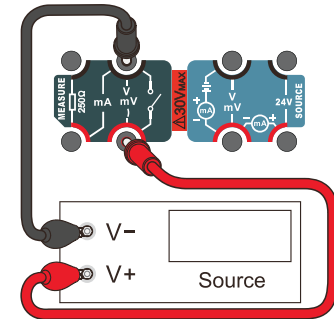

Figure 9.7 mV voltage measure

4) Press **F4** or **Enter/Hold** key to complete the set.

9.3.3 Voltage measure

1. Switch to the voltage measurement function, as shown in Figure 9.7 Connect the test line.
2. Before test, user can press **zero** to ZERO the measure value in short circuit.
3. The ruler display and the display resolution can be changed according to the range of the tested instruments.

Operate as follows:

- 1) Press **F1** to enter the scale range setting interface, as shown in Figure 9.9.
- 2) Press **↑**、**↓** key to select the scale range.
- 3) Press **←**、**→** key switch to the resolution settings screen, select the appropriate display digits.
- 4) Press **F4**、**Enter/Hold** key to complete the set.

9.3.4 On-off measure

1. Refer to Figure 9.10 to connect test leads and begin to measure.
2. The calibrator will record the source value if the switch state changed. And the last 11 output values will be records when there are multiple output values.
3. Press **Stat** or **F1** key to view the records of the switch

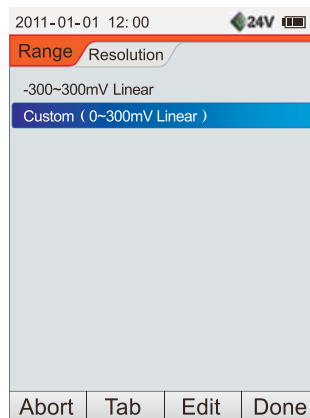

Figure 9.8 Setup mV voltage measure

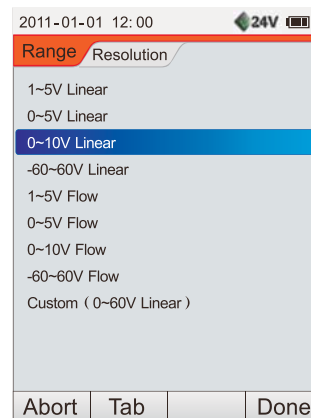

Figure 9.9 Setup voltage measure

trigger when On-Off is in capture mode.

9.3.5 Loop integrity measure

1. Refer to Figure 9.11 to connect test leads and begin to measure.
2. Under loop measure, using the key **F1** set resistance threshold: range: (1 ~ 2000) .

9.4 Source function

In the options of source (Figure 9.5) use , key to switch the 4 functions: current source, current simulate mV voltage source, voltage source.

Emphatically, when the calibrator switch to the current source, if the DC24V power supply is turned off, calibrator will turn on automatically.

9.4.1 Current source

1. User can refer to Figure 9.12 to connect all the test leads and begin to source.
2. The way of the output can be selected according to the calibrated instruments and easier used. Please refer chapter 9.1.4.
3. The ruler display can be changed according to the output of the calibrated gauge. Press **F2** key to enter the source interface.

Refer to Figure 9.13 :

- 1) User can choose to manually source mode, set the calibrator source range and mode.

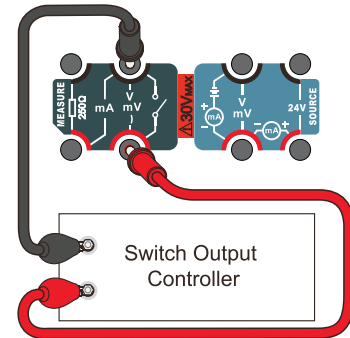

Figure 9.10 On-off measure

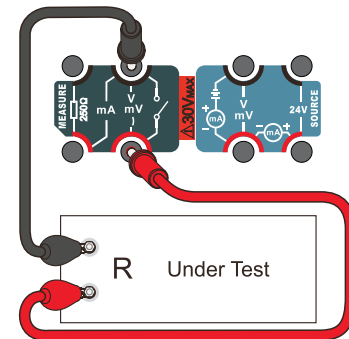

Figure 9.11 Loop integrity test

2) User can choose to automatic source mode, auto-stepping and auto-ramping mode.

9.4.2 Absorbing current

The same operation as current source, only the wiring diagram is different, as shown in Figure 9.14.

9.4.3 mV voltage source

1. In mV voltage source function, user can refer to Figure 9.15 to connect all the test leads and begin to source.
2. The way of the output can be selected according to the calibrated instruments and easier used. Please refer chapter 9.1.4.
3. The ruler display can be changed according to the output of the calibrated gauge. Press **F2** key to enter the source interface. Refer to Figure 9.16.

- 1) Supporting manually source mode, set source range and mode.

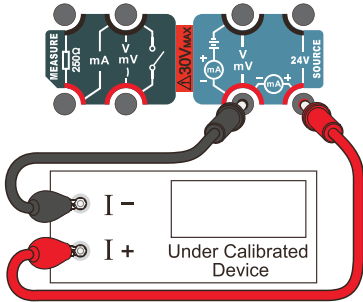

Figure 9.12 Current source

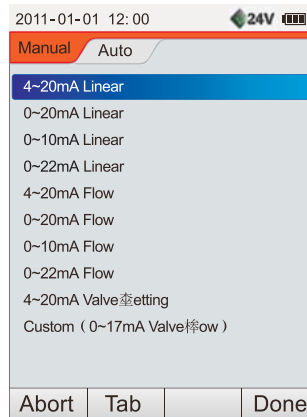

Figure 9.13 Current output

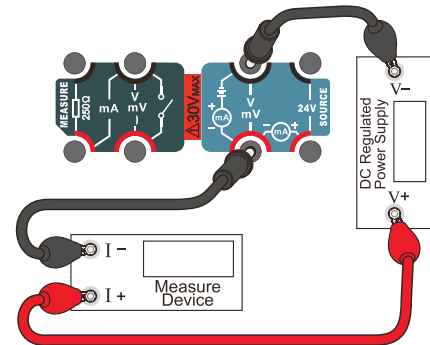

Figure 9.14 Current stimulate

2) Supporting to automatic source mode, auto-stepping and auto-ramping mode.

9.4.4 Source voltage

1. In the source voltage function, user can refer to Figure 9.15 to connect all the test leads and begin to source.
2. The way of the output can be selected according to the calibrated instruments and easier used. Please refer chapter 9.1.4.
3. The ruler display can be changed according to the output of the calibrated gauge. Press **F2** key to enter the source interface. Refer to Figure 9.17.

- 1) Supporting manually source mode, set source range and mode.
- 2) Supporting to automatic source mode, auto-stepping and auto-ramping mode.

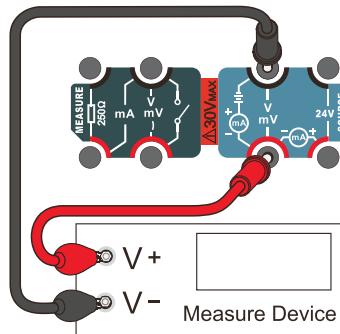

Figure 9.15 V (mV) Output

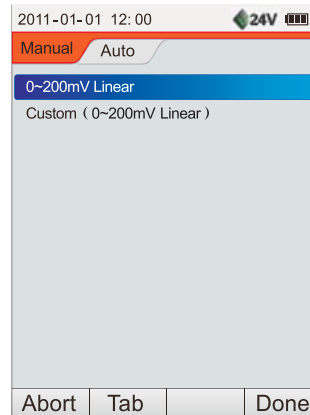

Figure 9.16 mV output

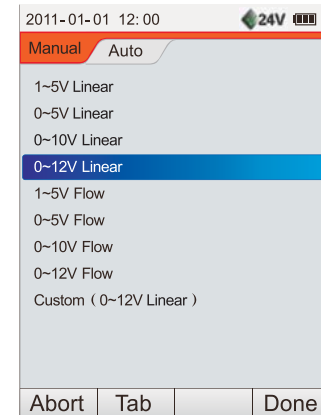

Figure 9.17 V output

9.5 Calibration functions

Before calibration, please read the instruction carefully. Do not operate the calibrator until fully understand. Before the end of calibration, user can use **F1** or **Esc** to return to the previous operation until exit calibration. And this calibration will not go into effect and previous data will be saved. When finish the last step of calibration, the calibrator will prompt “whether to save the new calibration data?” If choose yes, the new data will go into effect and be used, and the previous calibration data will be deleted permanently. In order to prevent mis–operation, a password is required to confirm this operation.

Important note: incorrect calibration will impact the accuracy of the calibrator. Even impact the normal work, so the operation of calibration function should be very careful.

There are two calibration types: calibration for measure item and source item. To choose the required calibration type, user can press **F4** or **Enter Hold** to the selected menu of calibration item. Before enter this item, a password is required. The password is: 312.

9.5.1 Measure calibration

1. Current calibration

a) As Figure 9.18, in the list, user can choose current and press **F4** or **Enter Hold** to calibrate.

b) As Figure 9.19, the calibrator will prompt the calibration points of the present item (-30mA , 0mA , 30mA) .

User can press **F4** or **Enter Hold** to calibrate.

c) As per calibrator prompt, user has to input the standard current of every calibration point in sequence and wait till the measure value is steady and press **F4** or **Enter Hold** to the calibration of next point. When the last point is finished, the calibrator will prompt “save the new data, yes? Or no?” User can choose “yes” to finish the calibration or choose

“no” to give up this calibration.

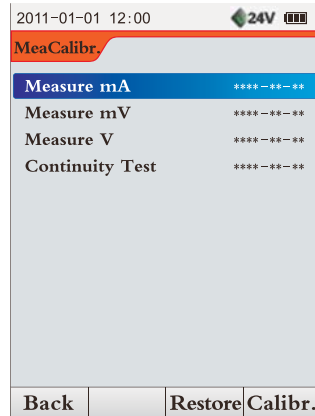

Figure 9.18 Measure and calibration list

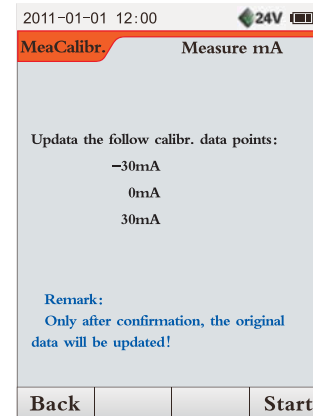

Figure 9.19 Current measure calibrate

2. mV voltage calibration

The operation is the same with current measure calibration. Calibration points are: -300mV、0mV、300mV.

3. Voltage calibration

The operation is the same with current measure calibration. Calibration points are: -60V、0V、60V.

4. Loop integrity test calibration

The operation is the same with current measure calibration. Calibration points are 0Ω、2000Ω.

9.5.2 Source calibration

1. Current calibration

- a) As Figure 9.20, user can select 22mA current in the source calibration items list by press **F4** or **Enter Hold**.
- b) As Figure 9.21, the calibrator will prompt the calibration points of the present item (4mA、20mA) . Use press **F4** or **Enter Hold** to start.
- c) A standard current gauge should be connected to measure the output of the calibrator.
- d) The first calibrated point is 4mA. When the standard gauge is steady, user has to record it and input to the calibrator as a real source value, then press **F4** or **Enter Hold** to the next point.
- e) The same operation as above till the last calibration point (20mA) .
- f) When the last point is finished, the calibrator will prompt “save the new data, yes? Or no?” User can choose “yes” to finish the calibration or choose “no” to give up this calibration.

2. mV voltage

The operation is the same with current source calibration. And the calibrator is standard voltmeter. The calibration points are 0mV、200mV.

3. Voltage

The operation is the same with current source calibration. And the calibrator is standard voltmeter. The calibration points are 0V、12V.

9.5.3 Return to the default value of measure and source calibration data

The interfaces in figure 9.18 and 9.20 are measure and source items list. When the calibrator is off factory, the calibration date

display ***_**_** When a certain item is calibrated, the calibrator will display the latest calibration data. To choose a calibration item by pressing **F3** and confirm this operation required by the calibrator. The calibration data of this item will be forcibly returned to default value. And the calibration data changes into ***_**_**

9.6 Date statistics function

In the main interface (Figure 9.1), press the key **Stat** enter into the statistical setting interface, as shown in Figure 9.22, a total of 6 options.

Average, minimum, maximum, and peak value of statistical function will be options, you can use the **F2** editing its parameters.

Migration, scaling is optional, you can use the key **F3** choose enable/disable, you can also use **F2** to edit its parameters.

Migration function is to remove a stable measurement value, scaling function is to convert the measured values correspond to physical values.

When choosing both the migration and scaling options at same time, due to migration statistics, priority than scaling, so the statistics are for the first migration and then the value of scaling.

1. Migration parameters editing

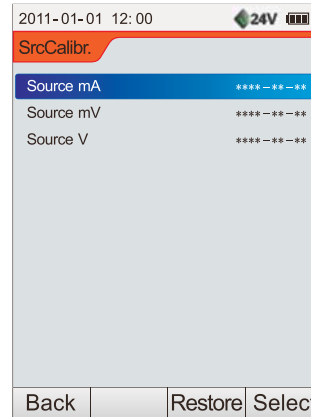

Figure 9.20 Source calibration list

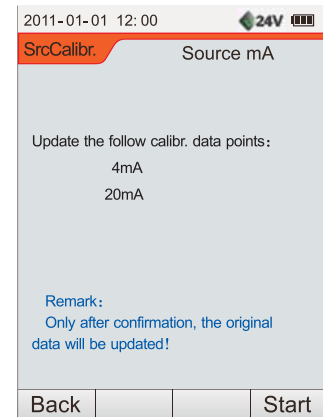

Figure 9.21 Current source calibration

Migration quantity: you can use numeric keys directly input migration quantity, the scope are the same with the range of the measurements and user can also use the key **F2** direct access to the current measured value as the migration quantity.

2. Scaling parameters of the editing function

Measurement upper/lower limit: default is the current upper limit and lower limit of measurements, it can be modified.

After starting the statistics function it will be the limits as a measurement of the scope of the item.

Scale upper/lower limit: after scaling, the corresponding upper and lower limit of the physical signal.

Scale unit: supporting temperature, pressure, flow and customized.

Units: temperature (°C、K、°F) , pressure (Pa、kPa、MPa、psi、bar、mbar、inHg、mmHg、inH₂O、mmH₂O、kgf/cm²) , flow (L/min、m³/s、m³/min、ft³/min、kg/s、kg/h、t/h、lb/h) , customized (supporting ABC keyboard input , length cannot exceed 8 characters).

Transfer function: scaling function of the conversion relationships, linear or flow.

3. Average parameter editing

The total number of samples: calculate the average number of set in N, for latest measured values of N.

Its setting range: 1 ~ 100.

Exclude the extreme value: removed when calculating the average set of extreme values (maximum and minimum) of log, the setting range is: must be less than half of the total.

Complete set of statistical parameters, press **F4** or **Enter Hold** key to enter the statistical functions interface, as shown in Figure 9.23. In this interface, user press **Stat** can enter the parameter setting interface (Figure 9.22) to re-set its

parameters, or stop the item statistics.

In the interface of statistical functions (Figure 9.23), press the key **Meas** to switch the item, the calibrator will automatically terminate the statistical function.

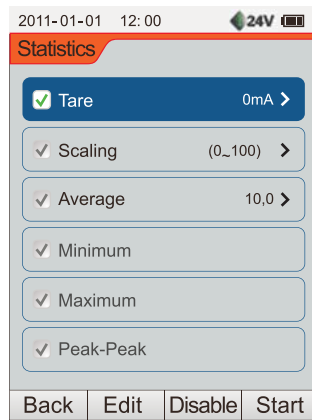

Figure 9.22 Statistics setting interface

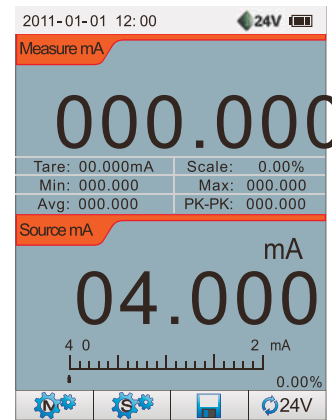

Figure 9.23 Statistic main interface



9.7 Snapshot saving and management

The calibrator provides a very simple saving mode:

In the main interface (Figure 9.1), press **Meas** once, a record will be saved. The saving content is including measure and source parameter, saving time and DC24V status.

1. Every record has its own name, the way of setting:

a) Auto number: every record has its own name. The calibrator can number the records in sequence by 1、2、...、100.

Press  once, the number will add one automatically. Calibrator can be set to record the prefix, users need to enter the long  under the management of the snapshot mode.

b) Manual input: press the key  need input the record name each time.

2. Amount of records: a maximum of 100 records.

3. Saving mode: every time press  to save, the calibrator will save in sequence until filled.

4. Press key  can be view, delete and all delete.

5. When connected to the matching software, the records can be uploaded to computer.

When the calibrator is in the state of “Hold” , the snapshot is the Hold data (Figure 9.24).

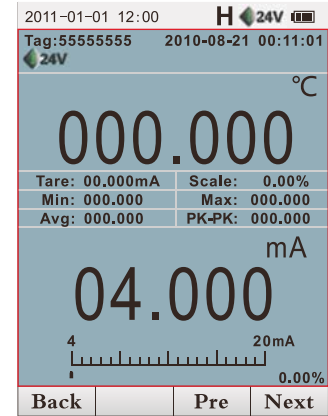

Figure 9.24 Snapshot viewing

9.8 Auto-record function

Calibrator provides a convenient storage way: auto-record function, high-capacity storage data can be up to twenty thousand, data records available online, index analysis, curve, or a list of automatic drawing. The specific operations can be divided into two steps: the new record and view records.

9.8.1 New record

In the main interface (Figure 9.1), press the key  to enter new records interface, such as shown in Figure 9.25, the

correct input parameters, press the key **F4** to automatically log into the main interface.

There need to set three parameters: record labels, duration and interval readings.

1. Record label

Record name, support the ABC keyboard input method, the length cannot exceed 11 characters.

Record name support the same name as operations, but cannot be empty, otherwise the error will be tip.

2. Duration

Continuous record storage time in minutes, maximum support 99,999 minutes.

3. Reading interval

Interval between two reading times, read in seconds, cannot be longer than the duration. At the bottom of the set interface gives the store information: storage space has been used, the required storage space and is given by calculating the remaining space on the tips. According to the duration and reading interval indicator the calibrator give tips.

When the automatic recording function is activated, the title bar of the main interface, here will be a flashing icon, in the menu bar shows the countdown storage time, and provides a stop function button. When the end of storage time or storage space is full, the calibrator automatically can stop and save the data.

9.8.2 Record view

In set interface (Figure 9.2), use the key  to select the records management options, press **F4** or  key can view

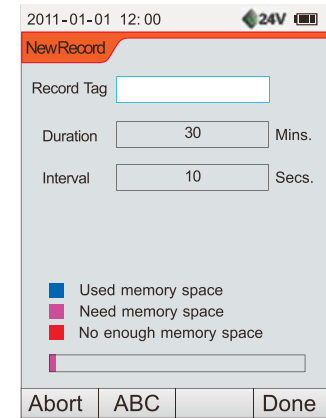

Figure 9.25 setup interface of new record

the log files and delete all records. In the record list, press **F4** or **Enter Hold** to enter the log file information interface, as shown in Figure 9.26.

In Figure 9.26, the calibrator displays the information of the log file: record labels, record number of points, start time, minimum, maximum, and volatility, given the curve constituted by the measured values.

In Figure 9.26, you can proceed as follows:

1. You can use the key **F2** to switch between the curve and the list.
2. You can use key **F3** to view the detail log file.
3. You can use the key **↑** to amplify the curve.
4. You can use the key **↓** to minify the curve.
5. You can start statistical functions, use keys **F4** to select the parameters of statistics show.

9.9 As Cal function

In order to improve user productivity, we provide a quick calibration tools As Cal for 4 kinds of field instruments which are loop display device, the sensor/transmitter, signal isolator/converter and limit alarm/switch. First, in the main interface (Figure 9.1), the instrument was seized under the input and output, measured calibration set, the output of the scale display range, and then press key **AsCal** into the calibrator As Cal function, as shown in Figure 9.27 Interface, select the instrument calibrated.

9.9.1 Loop display device

The loop display device means the input signal is given by the calibrator, but the measured value is reflected by the display,

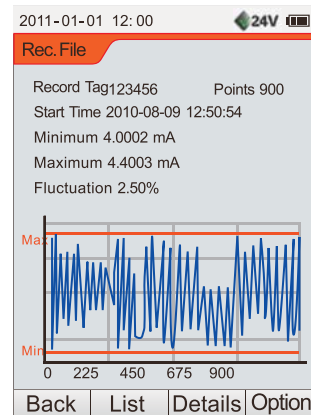

Figure 9.26 Record information interface

pointer, etc. Calibrator cannot directly read the measured value. Therefore, for such instruments, As Cal indication by the standards act, which is adjusted the calibrator to show the value of the calibration points, recording the output value of the calibrator at time in order to achieve calibration of the instrument.

The following are examples, specific methods of operation: use As Cal tool calibration input (4 ~ 20) mA in digital form.

1. In the main interface (Figure 9.1) is set calibrator: current output and change the scale range (4 ~ 20) mA, linear, press **AsCal** key tools into As Cal list, as shown in Figure 9.27.
2. Use **↑** or **↓** key to select the circuit display device options, press **F4** or **Enter Hold** key to enter As Cal execution interface, as shown in Figure 9.28.
3. Connect the test line well as shown in Figure 9.29, the calibrator output 4mA, manual fine-tuning the output calibrator signal to loop indicator shows the first calibration point (calibration point of 0%, 4mA).
4. Press **25%** key record 0% calibration point of calibrator output and enter the second calibration point (25%): 8mA.
5. Operate steps 3 and 4 turn-by-point until the completion of positive and negative trip circuit calibration.
6. In the calibration process, the calibrator will draw the error curve timely at the top of the screen, for user's reference.
7. In the calibration process, you can press **F2** key to switch the curve and the data interface (Figure 9.30) , and the data interface record the calibration

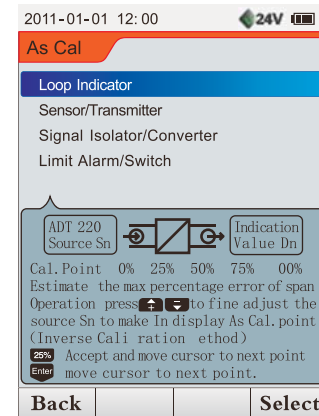

Figure 9.27

information in time: the output value of the calibration and the maximum error.

8. In the calibration process, you can use **Enter/ Hold** to move the cursor to any one calibration point, but only support one backward direction cycle movement, its operation does not record output.
9. In the calibration process, you can use the **F3** key to reset, this operation will clear the previous calibration data.
10. In the process, press **F1** or **Enter/ Hold** key to exit the calibration function.
11. You can use snapshot storage calibration function.

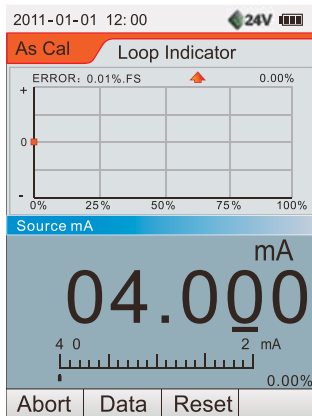

Figure 9.28 Curve display

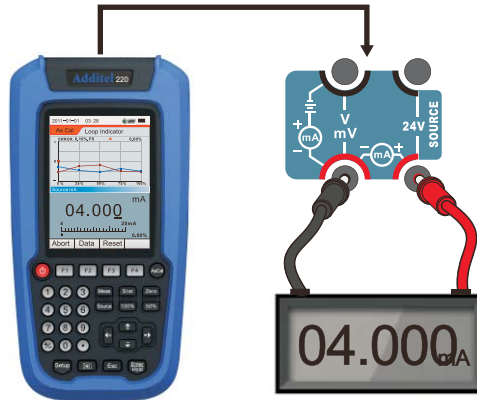

Figure 9.29 Loop calibration

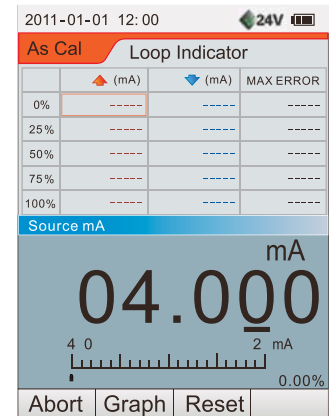

Figure 9.30 Data display

9.9.2 As Cal sensor/transmitter

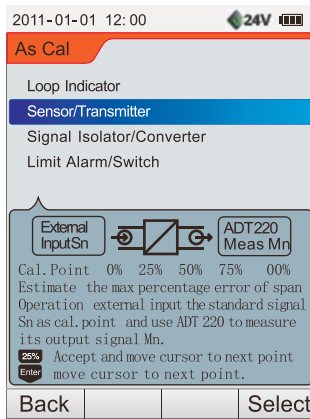

Figure 9.31

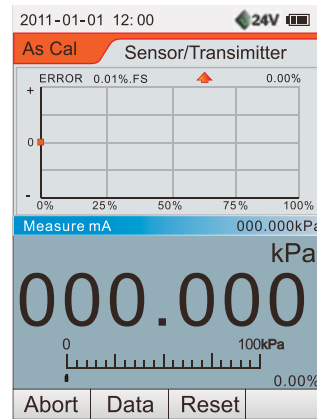

Figure 9.32 Curve display

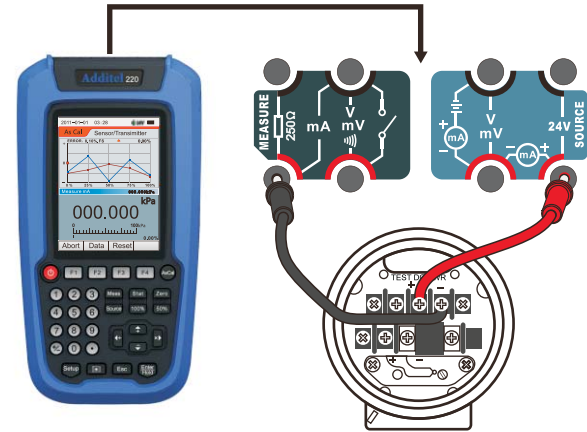

Figure 9.33 Pressure transmitter calibration

Such instrument output can be measured by calibration, but the input signal to be given by an external device, calibration data were recorded and analyzed.

The following are examples, specific methods of operation: use As Cal tool calibrate transmitter (input: 0 kPa ~ 100 kPa. output: 4mA ~ 20mA):

1. In the main interface (Figure 9.1) set calibrator: current measurement and change the scale range (4 ~ 20) mA, linear, the measurement resolution for the right to change the value.

2. You can start the statistics function, make the calibrated instrument output is (4 ~ 20) mA scaled to (0 ~ 100) kPa display.
3. Press **AsCal** key to enter As Cal tool list, as shown in Figure 9.31.
4. Use **↑** or **↓** key to select the sensor /transmitter options, press **F4** or **Enter Hold** key to enter As Cal execution interface, as shown in Figure 9.32.
5. As shown in Figure 9.33 Connect test line, the first external pressure transmitter calibration point (0%) of the standard input signal: 0 kPa.
6. Calibrator measure the output signal, press **25%** key loggers 0% calibration point measurements value and enter the second calibration point (25%): 25 kPa.
7. According to the prompt calibration points, followed by point by point by steps 3 and 4 to operate until the completion of the sensor /transmitter calibration of positive and negative travel.
8. In the calibration process, the calibrator will draw the error curve timely at the top of the screen, for user's reference.
9. In the calibration process, you can press **F2** key to switch the curve and the data interface (Figure 9.30), and the data interface record the calibration information in time: the output value of the calibration and the maximum error.
10. In the calibration process, you can use **Enter Hold** to move the cursor to any one calibration point, but only support one backward direction cycle movement, its operation does not record output.

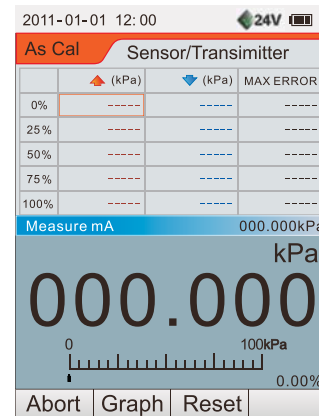

Figure 9.34 Data display

11. In the calibration process, you can use the **F3** key to reset. This operation will clear the previous calibration data.
12. In the process, press **F1** or **Esc** key to exit the calibration function.
13. You can use snapshot storage calibration function.

9.9.3 As Cal signal isolator/converter

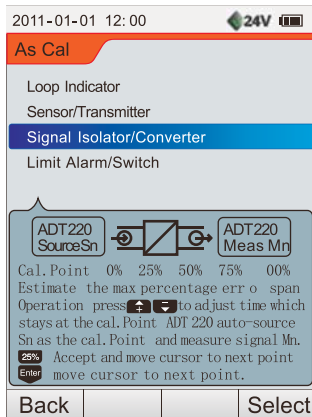

Figure 9.35

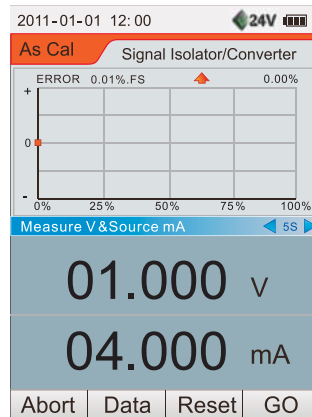

Figure 9.36 Curve display

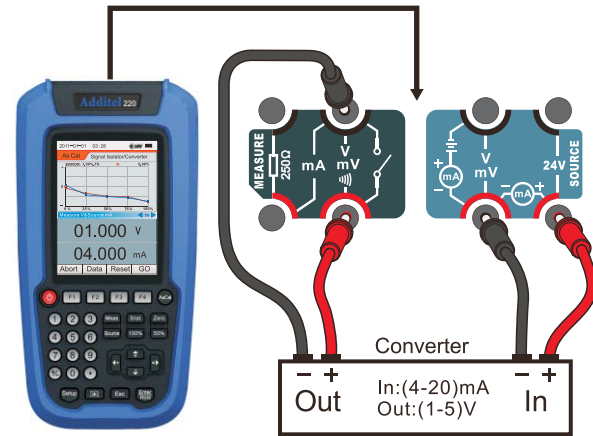

Figure 9.37 Transmitter calibration

Such instrument output can be measured by calibration, but the input signal to be given by an external device, calibration data were recorded and analyzed.

The following are examples, specific methods of operation: use As Cal tool calibrate signal isolator / converter (input: 4mA~20mA output: 1V~5V):

1. Set calibrator: current measurement and change the scale range (1~5) V, linear, the measurement resolution for the right to change the value, current output and change the scale range (4 ~ 20) mA, linear.
2. Press **AsCal** key to enter As Cal tool list, as shown in Figure 9.35.
3. Use **↑** or **↓** key to select the isolator / converter option, press **F4** or **Enter Hold** key to enter As Cal execution interface, as shown in Figure 9.36.
4. Use **←** or **→** key to set the isolator / converter automatically single-step time, and connect the test line as shown in Figure 9.37.
5. Automatically: press **F4** to start calibration, calibrator automatically turn-by-point implementation (for pause, continue to function), until the completion of isolator / converter calibration of positive and negative travel.

Manual: press the key **25%** to record points of measurement and calibration turn-by-point execution until the completion of isolator / converter calibration of positive and negative travel.

6. In the calibration process, the calibrator will draw the error curve timely at the top of the screen, for user reference.
7. In the calibration process, you can press **F2** key to switch the curve and the data interface (Figure 9.38), and the data interface record the calibration information in

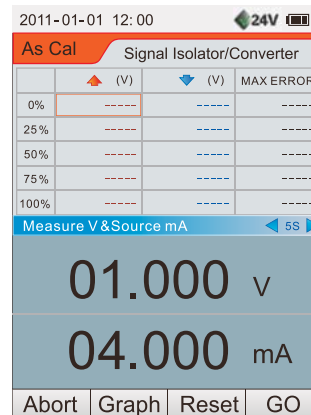





Figure 9.38 Data display









time

8. In the calibration process, you can use  to move the cursor to any one calibration point, but only support one backward direction cycle movement, its operation does not record output.
9. In the calibration process, you can use the  key to reset. This operation will clear the previous calibration data.
10. In the process, press  or  key to exit the calibration function.
11. You can use snapshot storage calibration function.

9.9.4 As Cal limit alarm/switch

Such instrument output can be measured by calibration, but the input signal to be given by an external device, calibration data were recorded and analyzed.

The following are examples, specific methods of operation: use As Cal tool calibrate switch (switching value 5mA, linear):

1. In the main interface (Figure 9.1) calibrator set: switch capture / current output (custom: 4mA ~ 6mA, linear), press  key entry As Cal tool list, as shown in Figure 9.39.
2. Use  or  key to select the limit alarm / switch option, press  or  key to enter As Cal execution interface (Figure 9.40).
3. Use  or  key to set the limit alarm / switch automatically performs a cycle length of time, according to Figure 9.41 shows the test line connected.
4. Press  to start the calibration, automatic calibrator output (for pause, continue to function) step signal sn as a limit alarm / switch the standard input.
5. Measure the limit on/off source signal in positive and negative stroke occurs when the flip sn, calibrator switch will be

calculated difference.

6. Check the calibration apparatus according to the results of the last three to calculate the average.
7. In the calibration process, you can use the **F3** key to reset; this operation will clear the previous calibration data.
8. In the process, press **F1** or **Esc** key to exit the calibration function.
9. You can use snapshot storage calibration function.

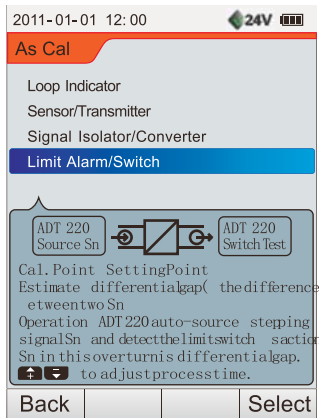

Figure 9.39

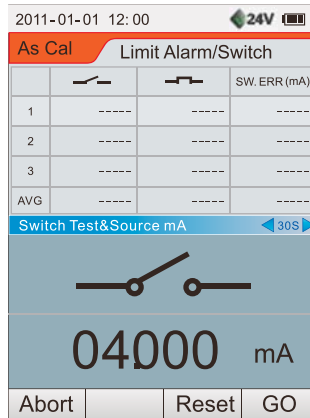

Figure 9.40 Data sheet

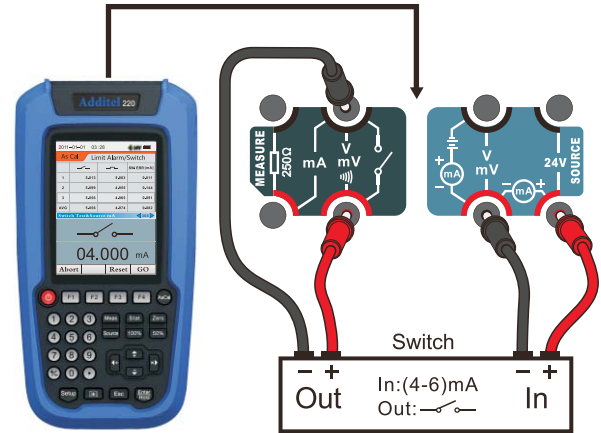

Figure 9.41 Current switch calibration

Appendix: Additel 220 Communication Commands :

Communication Commands

A: X: Knnnn: C0: C1: C2: C3 + end mark, hereinto:

A: 1 byte, calibrator communication address, (1 byte of ASCII code, such as 0x01, or 3 bytes of the string, such as 001)

X: 1 byte, W(write) or R(read) only

K: 1 byte, M(measure), S(source) or O(other operations) only

nnnn: 2-12 bytes, items operated by K command

C0, C1, C2, C3: parameter, refer to detail descriptions of commands

End mark: 1 Byte, character terminator (0x00) or line feed (0x0A) or carriage return (0x0D)

Loopback data format:

A: X: Knnnn: C0: C1: C2: C3 + end mark, hereinto:

A: Calibrator communication address

X: E (means the frame data is wrong) or F (loopback data correctly)

Knnnn: the same with the commands from upper computer

C0, C1, C2, C3: Loopback data or wrong information

End mark: 0 x 0 (Hexadecimal)

It is assumed that: parameter parsing similar "C0: 0-1 [300mV, 60V]" when the meaning is: 0 for 300mV 1 on behalf of 60V.

List of Additel 220 Communication Commands:

Commands								Instruction	Correct return value
A	X	Knnnn	C0	C1	C2	C3	End mark		
Communication Address	W	MVOL	C0	-	-	-		Measurement: voltage (C0: 0-1[300mV, 60V])	A: F: MVOL: OK+ End mark (0x0)
	W	MOHM	-	-	-	-		Measurement: resistance	A: F: MOHM: OK+ End mark (0x0)
	W	MSWI	-	-	-	-		Measurement: On/Off	A: F: MSWI: OK+ End mark (0x0)
	W	MCUR	-	-	-	-		Measurement: current	A: F: MCUR: OK+ End mark (0x0)
	W	MRANGE	C0	C1	C2	-		Measurement: range and transfer function, on/off and loop without this operation (C0: Min C1: Max C2: Transfer Fun 0-1[linear, flow])	A: F: MRANGE: OK+ End mark (0x0)
	W	MRESOLUTION	C0	-	-	-		Measurement: resolution(C0: No., 4-6[4, 5, 6]) on/off and loop without this operation	A: F: MRESOLUTION: OK+ End mark (0x0)
	W	MZERO	-	-	-	-		Clear measurements (current, voltage, resistance measurement circuit integrity)	A: F: MZERO: OK+ End mark (0x0)
	W	SVAL	C0	-	-	-		Sourcing: output(C0: value)	A: F: SVAL: OK+ End mark (0x0)
	W	SVOL	C0	-	-	-		Sourcing: voltage(C0: 0-1[200mV, 12V])	A: F: SVOL: OK+ End mark (0x0)
	W	SCUR	C0	C1	-	-		Sourcing: current(C0: 0-1[INT, EXT] C1: default output)	A: F: SCUR: OK+ End mark (0x0)
	W	SRANGE	C0	C1	C2	-		Sourcing: range and transfer function (C0: Min C1: Max C2: Transfer Fun, 0-2[linear, flow, valve ^[1]])	A: F: SRANGE: OK+ End mark (0x0)
	W	S25STEP	-	-	-	-		Sourcing: set the next point output under 25% stepping mode	A: F: S25STEP: OK+End mark(0x0)
	W	S100STEP	C0	-	-	-		Sourcing: set the next point output under 0%-100% stepping mode	A: F: S100STEP: OK+End mark(0x0)

		Commands						End mark	Instruction	Correct return value
A	X	Knnnn	C0	C1	C2	C3				
Communication Address	W	MSCSWITEM	C0	C1	C2	-		Measurement, Sourcing Calibration: switch measure, source C0: cal key C1: (0:measure 1: source) C2: cal item	A: F: MSCSWITEM: OK+End mark(0x0)	
	W	MSCRESTORE	C0	C1	C2	-		Measurement, Sourcing Calibration: return factory value C0:cal key C1:(0:measure 1:source) C2: measure item (0-3[30mA,300mV,60V, Loop]), source item(0-2[22mA, 200mV,12V])	A: F: MSCRESTORE: OK+End mark(0x0)	
	W	MCITEM	C0	C1	C2	C3		Measurement Calibration: C0: cal key C1: cal item[same as above]C2: cal point(electric signal item 3 cal points, Loop 2 cal points	A: F: MCITEM: OK+End mark(0x0)	
	W	SCITEM	C0	C1	C2	-		Sourcing Calibration: C0: cal key C1: cal item[same as above] C2: cal point(2 cal points)	A: F: SCITEM: OK+End mark(0x0) A: F: SCITEMVAL: OK+End mark(0x0)	
	W	SCITEMVAL	C0	C1	C2	C3		Sourcing Calibration: C0: cal key C1: cal item[same as above] C2: cal point C3: output	note: these two commands should use in conjunction with each other	
	W	OCLSSWDATA	-	-	-	-		Clear all On/Off trigger data	A: F: OCLSSWDATA: OK+End mark(0x0)	
	W	ODATEFAT	C0	-	-	-		Setting date format(C0: 012["year/month/date", "month/date/year", "date/month/year")	A: F: ODATEFAT: OK+End mark(0x0)	
	W	ODATE	C0	C1	C2	-		Setting date(C0: year C1: month C2: date)	A: F: ODATE: OK+End mark(0x0)	
	W	OTIME	C0	C1	C2	-		Setting time(C0: HH C1: MM C2: SS)	A: F: OTIME: OK+End mark(0x0)	
	W	OLANG	C0	-	-	-		Setting language(C0: 01[Chs, EN], this command will automatically refresh back to the main interface)	A: F: OLANG: OK+End mark(0x0)	
W	OLCDS	C0	-	-	-		Setting screen brightness value C0: (0-10), Contains 11 grades	A: F:OLCDS: OK+End mark(0x0)		

Commands								Instruction	Correct return value
A	X	Knnnn	C0	C1	C2	C3	End mark		
Communication Address	W	ORESTORE	C0	-	-	-		Reset the display to enter DIWEN forwarding mode	A: F: ORESTORE: OK+End mark(0x0)
	W	O24V	C0	-	-	-		Setting 24V power status C0: (OPEN, CLOSE)	A: F: O24V: OK+End mark(0x0)
	W	ORECDEL	C0	-	-	-		Deleting task documents with specified order numbers C0: (Documents sequence number , start from 1.)	A: F: ORECDEL: OK+End mark(0x0)
	W	ORECFAT	-	-	-	-		Format automatically record store, delete all log files	A: F: ORECFAT: OK+End mark(0x0)
	W	OMVBEEP	C0	-	-	-		Open or close the measured value over range buzzer C0: (OPEN, CLOSE)	A: F: OMVBEEP: OK+End mark(0x0)
	W	OCLSKEY	-	-	-	-		Clear key state is equivalent to not press any key	A: F: OCLSKEY: OK+End mark(0x0)
	W	OLOOPOHM	C0	-	-	-		Threshold set loop continuity of the resistance C0: (1~2000)	A: F: OLOOPOHM: OK+End mark(0x0)
	W	OADDRESS	C0	-	-	-		Setting serial port address C0: (1~121)	A: F: OADDRESS: OK+End mark(0x0)
	W	OSNPSHOT	C0	-	-	-		Capture a snapshot file (C0: file name[maximum of 12 English characters), uses automatic number mode if C0 is empty	A: F: OSNPSHOT: OK+End mark(0x0)
	W	OSNPPFORM	-	-	-	-		Formatting snapshot store area	A: F: OSNPPFORM: OK+End mark(0x0)
	W	OSNPDEL	C0	-	-	-		Deleting a snapshot file with specified order numbers C0: (documents sequence number, start from 1.)	A: F: OSNPDEL: OK+End mark(0x0)
	W	OLOCKKEY	C0	-	-	-		Lock keyboard, or unlock keyboard. [long press ESC, ENTER key unlock] C0: (TRUE: lock, FALSE: unlock, case Insensitive)	A: F: OLOCKKEY: OK+End mark(0x0)
	W	OKEYVALUE	C0	-	-	-		Send key value simulating buttons, simulating real key (C0: can be the key in Key Table, or its name)	A: F: OKEYVALUE: OK+End mark(0x0)

Commands							Function	Correct return value					
A	X	Knnnn	C0	C1	C2	Endmark		A	X	Knnnn	CX	End mark	
Communication Address	R	O	TEST	-	-	-	Testing (whether the communication is normal)	F		O	TEST	OK	0x0 hexadecimal
	R	M	ITEM	-	-	-	Read the present measurement item (items name+information on)	F		M	ITEM	Signal: item + minimum + maximum + transfer function Loop: item+ resistance threshold Switch: item	
	R	M	VAL	-	-	-	Read the present measured value	F		M	VAL	Switch: item + switch status (open or closed) Loop: item + + unit threshold resistance Other: item + measurement + unit	
	R	S	ITEM	-	-	-	Read present sourcing items	F		S	ITEM	Items +source range+ transfer function	
	R	S	VAL	-	-	-	Read present source value	F		S	VAL	Items+source value+units	
	R	M	SWDAT- ACOUNT	-	-	-	Quantity of reading On/Off trigger data	F		M	SWDAT- ACOUNT	Number of bars of data	
	R	M	SWDATA	C0	-	-	Through specified order number, read On/Off trigger data	F		M	SWDATA	State value+source value+units	
	R	M	SWDA- TALAST	-	-	-	Read the last On/Off trigger data	F		M	SWDATALAST	State value+source value+units	
	R	O	SNPNUM	-	-	-	Quantity of reading snapshot files	F		O	SNPNUM	Quantity of snapshot files	

Commands							Function	Correct return value				
A	X	Knnnn	C0	C1	C2	Endmark		A	X	Knnnn	CX	End mark
Communication Address	R	OSNPFIL	C0	-	-		Capture the snapshot files with specified order number	Communication Address	F	OSNPFIL	Strings composed by snapshot files	0x0 hexadecimal
	R	OADDRESS	-	-	-		Read host computer address		F	OADDRESS	Host computer(1-121)	
	R	OBATV	-	-	-		Read battery voltage		F	OBATV	Two batteries voltage(lv,hv)	
	R	O24V	-	-	-		Obtain 24V status		F	O24V	C0: 0-2[OPEN,CLOSE, LOOP POWER]	
	R	ODATETIME	-	-	-		Read system date		F	ODATETIME	Year: month: day: hour: minute: second	
	R	ODATEFAT	-	-	-		Read date format		F	ODATEFAT	(0-2[year/month/day, month/day/year, day/month/year)	
	R	OLCDS	-	-	-		Read screen brightness value		F	OLCDS	Percentage(0-100)%,contains 11 grades	
	R	OLANG	-	-	-		Obtain the order number of system language		F	OLANG	Language order number	
	R	OLOOPOHM	-	-	-		Obtain threshold resistance of loop test		F	OLOOPOHM	Resistance	
	R	ORECCOUNT	-	-	-		Obtain the number of log files		F	ORECCOUNT	The number of log files	

Commands							Function	Correct return value				
A	X	Knnnn	C0	C1	C2	Endmark		A	X	Knnnn	CX	End mark
Communication Address	R	ORECFILE	C0	C1	C2		Obtain the contents of log files (Note: must be in the main interface to run this command)	Communication Address	F	ORECFILE	C0: log file number, starting from 1 C1: file content type [0: file directory, 1: All the data variable values, separated by commas, 2: received only a single data variable value] C2: data type 0-5 [Origin, Max, Min, pk-pk, AVG, SCALE])	0x0 hexadecimal
	R	OKEYVALUE	-	-	-		Read key value		F	OKEYVALUE	Returns to key name if presses any button, returns NULL if does not	
	R	OMVBEEP	-	-	-		Beeper state when measured value exceeds range		F	OMVBEEP	OPEN/CLOSE	

Communication wrong information A: E: Knnnn: +MMMM hereinto

A: calibrator Communication Address, E: send the wrong message back, Knnnn: the same commands with what from the upper computer

MMMM: wrong order number, meaning:

"1001", // illegal command format or command overlength

"1002", // illegal parameter format or parameter overlength

"1003", // finds no matching commands in the commands set

"1004", // the current state does not support this command [operate pressure without pressure module][operate HART when HART is not available]

"1005", // illegal parameter format (invalid integer , floating points and so forth...)

"1006", // parameter overlength (the received commands packet is overlength, and cannot be resolved correctly)

"1007", // parameter exceeds the permitted range [setting sourcing or other parameters]

"1008", // wrong password

"1013", // wrong calibration

Note 1: when the output mode is set to valve position, the valve position value of the calibration points were: 1. $C0 * (1-5\%)$; 2. $C0$; 3. $C0 * (1+5\%)$; 4. $(C0 + C1) / 2$; 5. $C1 * (1-5\%)$; 6. $C1$; 7. $C1 * (1+5\%)$.

Additel Corporation

22865 Savi Ranch Parkway Ste F

Yorba Linda, CA 92887, USA

Phone: 714-998-6899

Fax: 714-998-6999

Email: sales@additel.com

website: www.additel.com



Additel Corporation

22865 Savi Ranch Parkway Ste F

Yorba Linda, CA 92887, USA

Phone: 714-998-6899

Fax: 714-998-6999

Email: sales@additel.com

website: www.additel.com