

INSTRUMENTS, LLC
 Direct Drive Difference
SIERRA PRECISION

THE INFORMATION DISCLOSED HEREIN WAS ORIGINATED BY AND IS THE PROPERTY OF 3D INSTRUMENTS, LLC AND EXCEPT FOR RIGHTS EXPRESSLY GRANTED TO THE UNITED STATES GOVERNMENT, 3D INSTRUMENTS, LLC RESERVES ALL PATENT, PROPRIETARY, DESIGN, USE, SALE, MANUFACTURING AND REPRODUCTION RIGHTS THERE TO.

REVISIONS		
REV.	DESCRIPTION	DATE



DIAL ADJUST
 Dyna-Mount Flange and Fitting

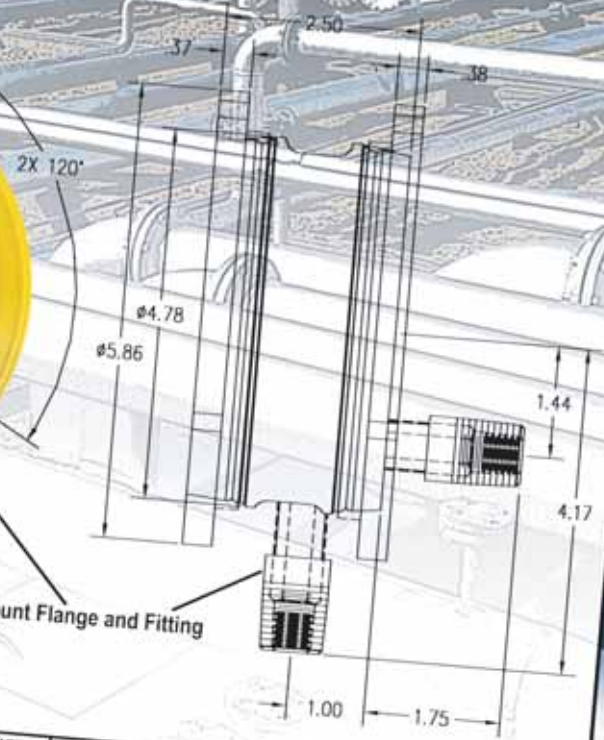

- UNLESS OTHERWISE NOTED
1. DIMENSIONS ARE IN INCHES.
 2. DIM. INTERPRETATION, DIMENSIONING AND TOLERANCING PER ASME-Y14.5-2000 AND ASME Y14.5.
 3. TOLERANCES:
 .XXX = ± .010 .XXX = ± .006
 .XXX = 1/2" CHAM. = 5°
 4. DIMENSIONS ARE SHOWN AFTER PLATING.
 5. SURFACE ROUGHNESS 63/ OR BETTER PER ASME B46.1.
 6. REMOVE BURRS AND BREAK SHARP EDGES .005 ± .015.
 7. MACHINED FILLET RADIUS .010 ± .030.
 8. THREADS PER ASME-B-7742.
 9. GENERAL MFG. REQUIREMENTS PER CP-01-001.

APPROVALS		DATE
DRAWN		
CHECKED		
ENGINEERING		
PRODUCTION		
G.A.		



TITLE
Accu-Drive Pressure Gauges

SIZE **A** CAGE CODE NO. **52159**

Designed from the ground up to handle your severe applications

REV.

Accu-Drive Pressure Gauges

Direct Drive Concept

At 3D Instruments, we believe that simple is beautiful!! Replacing the antiquated "C-shaped" bourdon tube in our Accu-Drive gauges is a unique helically wound bourdon... this is what we call the Direct Drive Difference. Our bourdon is coupled directly to the shaft pointer, which is the only moving part. Fewer moving parts translates to fewer gauge problems!! Regular recalibration is eliminated because there are no complex, wear-prone parts... like linkages and sectors. Linearity is built-in; no span adjustment is necessary – ever! Accuracy is maintained throughout the life of the gauge, which is much longer than those "old fashioned" gauges. Overpressure is not an issue... even 150% of span will not result in a calibration shift and the robust bourdon tube will withstand spikes of 500% of span without bursting. All 3D gauges use the finest materials of construction. The bourdon tube is made of Inconel, which is a highly elastic material with excellent corrosion resistance. All other wetted parts are in 316SS to meet the rigors of your most challenging applications.

Features

- Helically Wound Inconel Bourdon Tube
- Field adjustable fitting and flange on 4 1/2" ABS case
- All Wetted Components are 316 SS or Inconel
- Precision Anti-Friction Sapphire Shaft Bearings
- Shock Resistant and UV Stabilized ABS and Valox cases
- Human Engineered Dial
- Adjustable Zero Set-Point
- One Moving Part

User Benefits

- Lower "Cost of Ownership"
- No Recalibration Required
- Longer Field Service Life
- Greater Reading Accuracy
- Maintenance-Free Design
- Safer Operation

Direct Drive Vs. Liquid Filled Gauges

In many severe applications "C-shaped" pressure gauge cases are filled with a silicone liquid to dampen their movements and increase service life. Besides adding cost to the gauge, the liquid fill causes other problems... loss of accuracy, discoloration and added maintenance difficulties. 3D applies a high viscosity silicone dampener, known as GAD, directly to the outer layers of the bourdon tube. This GAD dampens the pointer movement in severe vibration and/or pulsation based applications thereby eliminating the need for liquid fill. In most instances a standard 3D Accu-Drive Gauge will easily replace a traditional liquid filled gauge. The 3D gauge will provide longer service life and lower field maintenance costs. When compared to liquid filled gauges, 3D gauges can last as much as 10x longer in severe vibration and pulsation service. Using 3D Accu-Drive Gauges will have a dramatically favorable impact on your gauge **cost of ownership!!**

Series-25 Dyna-Mount Field Adjustable Fitting/Flange



SIX YEAR WARRANTY

On the
Direct Drive Difference

3D Instruments LLC. warrants to the original purchaser of any 3D Instruments Accu-Drive Pressure Gauge that it will be free from defects in materials and workmanship for a period of six (6) years from the date of delivery to the purchaser. A copy of the full text of the 3D Instruments six year limited warranty is available online or upon request.

3D Helical Bourdon Tube Technology

The heart of the 3D Accu-Drive gauge is the helically wound Inconel bourdon tube. Inconel was chosen due to its excellent resistance to corrosion and its elasticity. There are two versions of helical bourdon tube: one being designed specifically for high pressures and the other designed for lower pressures. Each pressure range has subtle differences in bourdon tube design and manufacture. To the user the benefits of this painstaking high technology process are longer field life

with inherent accuracy and span. As an assembly in the Test or Process gauge, our coil provides lower cost of ownership and easier field use, simply because our gauges do not fail or require recalibration. In testing, some Accu-Drive gauges have been cycled over a million times with no appreciable wear or effect on accuracy. Some 3D gauges have been in constant service for more than 25 years, replacing traditional gauges which had failed in the same service within weeks.



PRODUCT ORDERING INFORMATION

Process Gauges

Complete Order Table can be found on page 7 of this PDF.

PART NO.	CASE TYPE (CHECK ONE)		BASIC CLASSIFICATION (CHECK ONE)		ACCURACY (CHECK ONE)		SCALE SIZE (CHECK ONE)		SCALE CODE & RANGE PSIG (ISO METRIC) (CHECK ONE)												CONNECTION SIZE & TYPE (CHECK ONE)																			
	24	25	1	2	5	0	7	2	4	5	-	48	21	22	23	24	45	25	26	27	28	29	31	32	33	34	35	36	37	38	39	41	B	C	11	14	15	21		
	Series 24 Valox Turret Case (Waterproof)	Series 25 ABS or ST Case	Compound†	30 in Hg-30 to 300 psig	Vacuum**	Pressure	1/10% midscale	1% (Receiver gauge only)	2.5"	4.5"	6"	Dial	30-0-30 psig (Compound only)†	0-30 psig (0-20 kPa)	0-60 psig (0-40 kPa)	0-100 psig (0-70 kPa)†	0-150 psig (0-100 kPa)†	0-200 psig (0-140 kPa)†	0-300 psig (0-210 kPa)†	0-400 psig (0-280 kPa)†	0-500 psig (0-350 kPa)†	0-600 psig (0-420 kPa)†	0-800 psig (0-560 kPa)†	0-1,000 psig (0-700 kPa)†	0-1,500 psig (0-1,050 kPa)†	0-2,000 psig (0-1,400 kPa)†	0-3,000 psig (0-2,100 kPa)†	0-4,000 psig (0-2,800 kPa)†	0-5,000 psig (0-3,500 kPa)†	0-6,000 psig (0-4,200 kPa)†	0-8,000 psig (0-5,600 kPa)†	0-10,000 psig (0-7,000 kPa)†	0-15,000 psig (0-10,500 kPa)†	0-20,000 psig (0-14,000 kPa)†	1/4" NPT Male	1/2" NPT Male**	Black	Yellow 4.5" Only	Stainless 2.5" & 4.5" Only	Black

†Compound gauge – Pressure accuracy 0.5% at mid scale, 1% overall
Vacuum accuracy 1.0% to 20" Hg., 2.0% 21" to 30" Hg.
Example P/N: 25104-48811 = 30" Hg-0-30 psig

**Vacuum gauge – 135° dial arc. Accuracy 1.0% to 20" Hg., 2% 21" to 30" Hg.
Accuracy based on 0-30" Hg scale

*2-1/2" dial size – Front flange only, bottom or back fitting connection on black ABS plastic case. For panel mount order optional RS426-1. Stainless steel case is available with all flange and fitting options (except detached flange).

Ultra high pressure – Pressure accuracy 1.0% up scale, 2.0% down scale.
**1/2" NPT fitting – Not recommended for ranges above 6,000 psig.

Test Gauges

PART NO.	CASE TYPE (CHECK ONE)		BASIC CLASSIFICATION (CHECK ONE)		ACCURACY (CHECK ONE)		SCALE SIZE (CHECK ONE)		SCALE CODE & RANGE PSIG (ISO METRIC) (CHECK ONE)												CONNECTION SIZE & TYPE (CHECK ONE)																								
	25	1	2	5	6	4	5	2	4	5	6	7	-	48	21	22	23	24	25	26	27	28	29	31	32	33	34	35	36	37	38	39	41	B	C	11	12	13	14	15	21	22	23	24	
	Series 25 ABS Case	Compound†	Vacuum**	0.5% Accuracy Only	Pressure	0.25% Accuracy	0.50% Accuracy	2.5"	4.5"	6"	8.5"	12"	Dial	30-0-30 psig (Compound only)†	0-30 psig (0-20 kPa)	0-60 psig (0-40 kPa)	0-100 psig (0-70 kPa)†	0-150 psig (0-100 kPa)†	0-200 psig (0-140 kPa)†	0-300 psig (0-210 kPa)†	0-400 psig (0-280 kPa)†	0-500 psig (0-350 kPa)†	0-600 psig (0-420 kPa)†	0-800 psig (0-560 kPa)†	0-1,000 psig (0-700 kPa)†	0-1,500 psig (0-1,050 kPa)†	0-2,000 psig (0-1,400 kPa)†	0-3,000 psig (0-2,100 kPa)†	0-4,000 psig (0-2,800 kPa)†	0-5,000 psig (0-3,500 kPa)†	0-6,000 psig (0-4,200 kPa)†	0-8,000 psig (0-5,600 kPa)†	0-10,000 psig (0-7,000 kPa)†	0-15,000 psig (0-10,500 kPa)†	0-20,000 psig (0-14,000 kPa)†	1/4" NPT Male	1/2" NPT Male**	Black	Green	Red	Yellow	Stainless 2.5" & 4.5" Only	Black	Green	Red

†Compound gauge – Pressure accuracy 0.5% and 0.25%
Vacuum accuracy 0.5% to 20" Hg., 1.0% 21" Hg.
Example P/N: 25144-48B11 = 30" Hg-0-30 psig

**Vacuum gauge – 135° dial arc. Accuracy 0.5% to 20" Hg., 1% 21" to 30" Hg.
Example P/N: 25254-21B11 = 30" Hg-0 vacuum

*2 1/2" dial size – Front flange only, bottom or back fitting connection on black ABS plastic case. For panel mount order optional RS426-1. Stainless steel case is available with all flange and fitting options.

#High pressure – Pressure accuracy 0.25% up scale, 0.50% down scale. Series 2554 only

How To Order:

To obtain your part number for the type of gauges you need, select on variation under each column heading. Place a check mark immediately below the part number for each variation. When complete, write the part number above each check. The resulting number is your part number. (Note: The first two numbers are always 24 or 25 as indicated.) Example: 25544-31B13. For ISO and Metric scales add suffix to the end of number

ISO and Metric Scale	
Type	Suffix
kilopascals/megapascals*	ISO
BAR	ISB
kg/cm ²	ISK



Note; for dual scale add 'D' to suffix ie; psi & bar = ISBD. PSI are typically on outer arc.

*Above 1000 PSI

RS380-1 Filter. The RS380-1 Filter is standard equipment on all 3D gauges to prevent particles from entering the bourdon coil. Made of 300 series stainless steel for corrosion resistance, RS380-1 is easily removed for cleaning. Filters are available separately and should be replaced regularly if media has particles.

Custom dial faces. 3D's design and engineering department can provide special dial to customers' specifications upon request. Customized faces may show forces or weight, extended ranges, special color, corporate logo-type, or legends.

Other Direct Drive Difference Pressure Gauges

STAINLESS STEEL	SANITARY	REFRIGERATION
<ul style="list-style-type: none"> “Direct Drive” technology – 6 year warranty!! 300 series SS case - 2 1/2" and 4 1/2" dial sizes Pressure ranges to 20,000 psi Optional mounting flanges  <p>Refer to 3D Document: KT-013</p>	<ul style="list-style-type: none"> “Direct Drive” technology – 6 year warranty!!* 1 1/2" or 2" 316L SS Ladish Tri-Clamp seal 300 Series SS case – 2 1/2" and 4 1/2" dial sizes 1% of full scale or better accuracy for many ranges Pressure ranges to 1500 psi; compound available  <p>Refer to 3D Document: KT-091 * Seal & Fill have 1 year warranty</p>	<ul style="list-style-type: none"> “Direct Drive” technology – 6 year warranty!! ABS, Valox Turret and SS cases available Field adjustable fitting on 4 1/2" ABS & Valox versions Various refrigerant versions  <p>Refer to 3D Document: KT-096</p>

CONNECTION SIZE & TYPE (CHECK ONE)		SERIES 25 ENCLOSURE FLANGE & FITTING LOCATION & CASE COLOR (CHECK ONE)												SERIES 24 ONLY											
		Flange: Front Fitting: Bottom	Flange: Front Fitting: Back	Flange: Back Fitting: Bottom	Flange: Back Fitting: Back	Flange: None Fitting: Bottom	Flange: None Fitting: Back	Flange: Detached Fitting: Bottom	Flange: Detached Fitting: Back	Turret Fitting: Bottom	Turret Fitting: Back														
11	14	15	21	24	25	31	34	35	41	44	45	51	54	55	61	64	65	71	74	81	84	91	94	01	04

Black ABS
Stainless steel
(detached flange).

Note: Quotations for custom models and modifications are available on request.
Connections: Consult factory for connection sizes and types not listed in chart.
Enclosures: Consult factory for cases suitable for Skydrol or equivalent service.
Note: All accuracy statements are based on total span of selected bourdon tube.
"GAD" Silicone Dampener will add .25% of span to the specified gauge accuracy.

ENCLOSURE FLANGE & FITTING LOCATION & CASE COLOR (CHECK ONE)												4.5" DIAL SIZE ONLY																				
		Flange: Front Fitting: Bottom	Flange: Front Fitting: Back	Flange: Back Fitting: Bottom	Flange: Back Fitting: Back	Flange: None Fitting: Bottom	Flange: None Fitting: Back	Flange: Detached Fitting: Bottom	Flange: Detached Fitting: Back																							
21	22	23	24	25	31	32	33	34	35	41	42	43	44	45	51	52	53	54	55	61	62	63	64	65	71	72	73	74	81	82	83	84

Stainless steel
4 only

Ultra high pressure – 15,000 psi pressure accuracy 0.5% up scale, 1.0% down scale
20,000 psi pressure accuracy 1.0% up scale, 2.0% down scale
(Not available on 2554 series)
**1/2" NPT fitting – Not recommended for ranges above 6,000 psig.

Process - 4 1/2" Series 24 Turret Case



Process - 4 1/2" Series 25 ABS Case





Test - 4 1/2" Series 25 ABS Case



Max Pressure Pointer. A "Dead Hand" pointer is moved by the gauges indicating pointer on increasing pressure, and the "Dead Hand" Pointer remains at maximum pressure when the gauges pressure returns to normal or zero. The assembly is mounted on the gauge crystal and has an external reset knob to reposition the pointer. This pointer is available on the 4 1/2, 6, 8 1/2 and 12 inch gauges. (Max Pressure pointer may move when used in Shock or vibration applications). Add "GAV" to the end of the part number.

Complete Order Table can be found on page 7 of this PDF.

SENDER	RECEIVER
	<ul style="list-style-type: none"> Direct Drive" technology – 6 year warranty!! 2 1/2", 4 1/2" and 6" dial sizes 3-15 psi and 3-27 psi versions Many dial scale units are available Field adjustable fitting on 4 1/2" version <p>Refer to 3D Document: KT-015</p> 

PRODUCT DESCRIPTIONS / SPECIFICATIONS

Process Gauges

TLG "Tough Little Gauges"

3D Process Gauges are called TLG's for "Tough Little Gauge". Small wonder, our process gauges are designed specifically for the toughest conditions in your process. Typically a 3D TLG can last 4-10 times longer than a standard gauge, even if the standard gauge has been liquid filled. The "Tough Little Gauge" features a robust case of engineered plastic either ABS (Series 25) or waterproof Valox (Series 24) and is available in diameters of: 2 1/2", 4 1/2", and 6" with 8 1/2" and 12" available on request. The "Dyna-Mount" 4 1/2" TLG is standard with a special swivel fitting and moveable flange. The gauge can be changed to front or back flange and bottom or back mount (Except ranges lower than 60 psi) in the field with no more than a screwdriver. Standard accuracies are 0.5% mid-scale. Pressure ranges available are from vacuum to 20,000 psi.

Process Dial Graduation Chart (Accuracy: 0.5% full scale @ midscale)

Pressure Range (psig)	Major Figure Interval (psig)	Mid Graduation (psig)	Minor Graduation* (psig)
30" Hg-0 Vac	5	5	0.5
0-30	5	1	0.2
0-60	5	1	0.5
0-100	10	5	1.0
0-150	10	5	1.0
0-160	20	10	2.0
0-200	20	10	2.0
0-300	50	10	2.0
0-500	50	10	5.0
0-600	50	10	5.0
0-1,000	100	50	10.0
0-1,500	100	50	10.0
0-2,000	200	100	20.0
0-3,000	500	100	20.0
0-4,000	500	100	50.0
0-5,000	1,000	500	50.0
0-6,000	1,000	500	50.0
0-8,000	1,000	500	100.0
0-10,000	1,000	500	100.0
0-15,000	1,500	500	100.0
0-20,000	2,000	1,000	100.0

*2.5" Dial size may have fewer divisions

Series-25 Gauge Dimensions

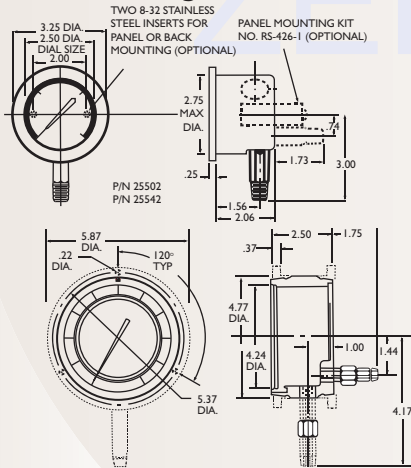

P/N 25504
P/N 25554
P/N 25544

Panel cut out
4.9" to 5"

Process & Test Gauges Specifications

Pressure Ranges:

0-30 psig to 0-20,000 psig equivalent ISO and Metric Scales

Compound Ranges:

30" Hg/0-30 psig to 30" Hg/0-300 psig

Receiver Gauges:

3-15 psig or 3-27 psig linear or square root scales

Proof Pressure without calibration shift:

150% of maximum rated pressure*

All Accu-Drive Gauges can withstand full vacuum without calibration shift.

Burst Pressure: 500% of Scale Pressure*

Operating Media:

Any media suitable for contact with stainless steel/inconel.

Calibration: Vertical as standard

Accuracy:

Process – ± 0.5% of span at mid-range, ± 1.0% overall*

Test – ± 0.25% or ± 0.50% of span†

No tapping required, includes all friction, hysteresis, linearity variations

Approximately 100ms from 0 to full scale (gas service)

Ambient Temperature:

–65°F to + 190°F (–54°C to +88°C)**

Service Media Temperature:

–65°F to + 400°F (–54°C to + 204°C)

Higher temperatures allowable depending on installation

Life:

250,000 cycles minimum to 1,000,000,*

80% of full scale

Bourdon Tube Volumes: 100 psi = 0.05 cu in (approximate) 10,000 psi = 0.01 cu in (approximate) + 5% from zero to full scale

Dial Sizes:

Process – 2 1/2" (64 mm)

4 1/2" (114 mm) 6" (152 mm)

Test – 2 1/2" (64 mm) 4 1/2" (114 mm)

6" (152 mm) 8 1/2" (216 mm) 12"

(305 mm)

Repeatability: ±0.025% full scale

Sensitivity: ±0.025% full scale

Materials of Construction:

Case – Series-24: Valox; Series-25: ABS

Dial, Capillary tube, fittings, screws, and rivets – Stainless Steel**

Sensing Material – Inconel

Gauges conform to ANSI B40 1991 for "Gauge, Pressure and Vacuum, Dial Type, Elastic Element."

*Except on ultra high pressure => 10,000 psi

**2 1/2" dial, plastic

†Except 30 PSI and Caisson gauges

‡Test gauges are traceable to N.I.S.T.

Other available as an option

##Low temperature on undamped gauges only

Series-25 Test Gauge Dimensions in Inches (Millimeters)

Model No.	A	B	C	D	E	F	G	H	K	L	M	Panel
255-5	6.31 (160.3)	2.50 (63.5)	7.63 (193.8)	1.00 (25.4)	7.00 (177.8)	2.13 (54.1)	5.72 (145.3)	1.65 (41.9)	0.28 (7.1)	0.50 (12.7)	6.00 (152.4)	6.50 (165.1)
255-6	8.81 (223.8)	2.50 (63.5)	10.20 (259.1)	1.00 (25.4)	9.63 (244.6)	2.13 (54.1)	6.97 (177.0)	1.65 (41.9)	0.28 (7.1)	0.50 (12.7)	8.50 (215.6)	9.00 (228.8)
255-7	12.50 (317.5)	2.50 (63.5)	14.13 (358.9)	1.00 (25.4)	13.50 (342.9)	2.13 (54.1)	8.82 (224.0)	1.65 (41.9)	0.28 (7.1)	0.50 (12.7)	12.00 (304.8)	12.75 (323.9)

Test Gauges

The 3D Accu-Drive Test Gauge series gives you a choice of two different degrees of accuracy to match your application. All 3D accuracy figures are real: they include all friction, error, hysteresis, and linearity variations. And 3D gauges maintain their rated accuracy over the entire life of the gauge. With no gears or wear points there is no need for recalibration.

Every dial is clearly marked for fast, accurate reading with calibrations covering a 270° arc. Parallax is corrected on the test gauges by a neutral glare-free face and a corrosion resistant stainless steel dial, incorporating a polished mirror band. Our test gauges are easy to zero with a front mounted zero adjust screw, virtually the only adjustment necessary over the life of the gauge. 3D test gauges are ideal for field calibrations where rough service conditions cause the need for frequent recalibrations in lesser gauge technologies. 3D Test Gauges are available in: 2 1/2", 4 1/2", 6", 8 1/2" and 12" diameters. Accuracies available are 0.5% and 0.25% of span†. A variety of case configurations and colors is provided so that you can match the exact pressure calibration instrument required for your service.

Test Dial Graduation Chart (Accuracy: 0.25% full scale)

Pressure Range (psig)	Major Figure Interval (psig)	Minor Figure Interval (psig)	Major Grad. (psig)	Inter Grad. (psig)	Minor Grad.* (psig)
30" Hg-0 Vac	5	2	10	1	0.25
0-30	10	1	5	1	0.1
0-60	10	1	10	1	0.2
0-100	10	1	10	1	0.5
0-150	10	2	10	1	0.5
0-200	10	2	10	2	1.0
0-300	50	5	50	5	1.0
0-500	100	10	100	10	2.0
0-600	100	10	100	10	2.0
0-1,000	100	20	100	10	5.0
0-1,500	100	20	100	10	5.0
0-2,000	100	20	100	20	10.0
0-3,000	500	50	500	50	10.0
0-4,000	500	100	500	100	20.0
0-5,000	1,000	100	1,000	100	20.0
0-6,000	1,000	100	1,000	100	20.0
0-8,000	1,000	200	1,000	200	50.0
0-10,000	1,000	200	1,000	200	50.0
0-15,000	1,000	250	1,000	250	100.0
0-20,000	2,000	500	2,000	500	100.0

*2.5" Dial size may have fewer divisions

Series-25 Gauge Dimensions

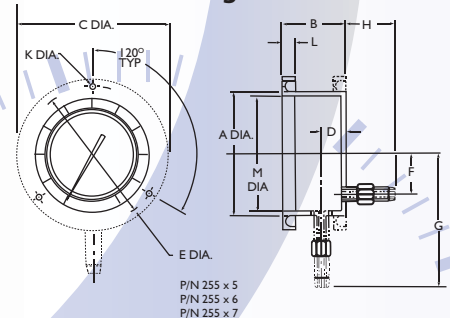

3D - The Direct Drive Difference

"Dyna-Mount" snap-on flange available only on the 4 1/2" Series-25 gauges. Fits front or back for panel or flush mounting. Can be removed for local mounting.

Tough, rugged ABS plastic case

Rear-mounted blow-out plug

Corrosion-resistant construction

Inconel bourdon tube

Accurate, easy-to-read dial

Precision sapphire bearings

Simple external Zero adjust

"Dyna-Mount" convertible fitting can be rotated from bottom to back in the field on 4.5" industrial gauges



(4 1/2" Series-25 Gauge Pictured)



INSTRUMENTS, LLC
Direct Drive Difference
SIERRA PRECISION

2900 E. White Star Avenue, Anaheim, California 92806
phone: 714.399.9200 fax: 714.399.9221
www.3Dinstruments.com
e-mail: info@3Dinstruments.com

Your Local Distributor

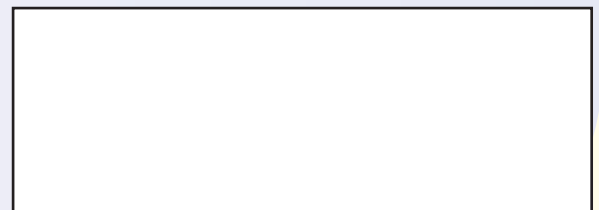

PRODUCT ORDERING INFORMATION

Process Gauges

PART NO.	CASE TYPE (CHECK ONE)	BASIC CLASSIFICATION (CHECK ONE)	ACCURACY (CHECK ONE)	SCALE SIZE (CHECK ONE)	SCALE CODE & RANGE PSIG (ISO METRIC) (CHECK ONE)	CONNECTION SIZE & TYPE (CHECK ONE)	SERIES 25 ENCLOSURE FLANGE & FITTING LOCATION & CASE COLOR (CHECK ONE)												SERIES 24 ONLY																																							
							Flange: Front Fitting: Bottom	Flange: Front Fitting: Back	Flange: Back Fitting: Bottom	Flange: Back Fitting: Back	Flange: None Fitting: Bottom	Flange: None Fitting: Back	Flange: Detached Fitting: Bottom	Flange: Detached Fitting: Back	Turret Fitting: Bottom	Turret Fitting: Back																																										
24 25	1	2	5	0	7	2	4	5	-	48	21	22	23	24	45	25	26	27	28	29	31	32	33	34	35	36	37	38	39	41	B	C	11	14	15	21	24	25	31	34	35	41	44	45	51	54	55	61	64	65	71	74	81	84	91	94	01	04

*Compound gauge – Pressure accuracy 0.5% at mid scale, 1% overall
 Vacuum accuracy 1.0% to 20" Hg., 2.0% 21" to 30" Hg.
 Example P/N: 25104-48811 = 30" Hg-0-30 psig
 **Vacuum gauge – 135° dial arc. Accuracy 1.0% to 20" Hg., 2% 21" to 30" Hg.
 Accuracy based on 0-30" Hg scale
 *2-1/2" dial size – Front flange only, bottom or back fitting connection on black ABS plastic case. For panel mount order optional RS426-1. Stainless steel case is available with all flange and fitting options (except detached flange).
 ## Ultra high pressure – Pressure accuracy 1.0% up scale, 2.0% down scale.
 **1/2" NPT fitting – Not recommended for ranges above 6,000 psig.
 Note: Quotations for custom models and modifications are available on request.
 Connections: Consult factory for connection sizes and types not listed in chart.
 Enclosures: Consult factory for cases suitable for Skydrol or equivalent service.
 Note: All accuracy statements are based on total span of selected bourdon tube.
 "GAD" Silicone Dampener will add .25% of span to the specified gauge accuracy.

Process - 4 1/2" Series 24 Turret Case



Test Gauges

PART NO.	TYPE	BASIC CLASSIFICATION (CHECK ONE)	ACCURACY (CHECK ONE)	SCALE SIZE (CHECK ONE)	SCALE CODE & RANGE PSIG (ISO METRIC) (CHECK ONE)	CONNECTION SIZE & TYPE (CHECK ONE)	ENCLOSURE FLANGE & FITTING LOCATION & CASE COLOR (CHECK ONE)								4.5" DIAL SIZE ONLY																																																									
							Flange: Front Fitting: Bottom	Flange: Front Fitting: Back	Flange: Back Fitting: Bottom	Flange: Back Fitting: Back	Flange: None Fitting: Bottom	Flange: None Fitting: Back	Flange: Detached Fitting: Bottom	Flange: Detached Fitting: Back	Green	Yellow																																																								
25	1	2	5	6	4	5	2	4	5	6	7	-	48	21	22	23	24	25	26	27	28	29	31	32	33	34	35	36	37	38	39	41	B	C	11	12	13	14	15	21	22	23	24	25	31	32	33	34	35	41	42	43	44	45	51	52	53	54	55	61	62	63	64	65	71	72	73	74	81	82	83	84

*Compound gauge – Pressure accuracy 0.5% and 0.25%
 Vacuum accuracy 0.5% to 20" Hg., 1.0% 21" Hg.
 Example P/N: 25144-48811 = 30" Hg-0-30 psig
 **Vacuum gauge – 135° dial arc. Accuracy 0.5% to 20" Hg., 1% 21" to 30" Hg.
 Example P/N: 25254-21B11 = 30" Hg-0 vacuum
 *2 1/2" dial size – Front flange only, bottom or back fitting connection on black ABS plastic case. For panel mount order optional RS426-1. Stainless steel case is available with all flange and fitting options.
 # High pressure – Pressure accuracy 0.25% up scale, 0.50% down scale. Series 2554 only
 ## Ultra high pressure – 15,000 psi pressure accuracy 0.5% up scale, 1.0% down scale
 20,000 psi pressure accuracy 1.0% up scale, 2.0% down scale (Not available on 2554 series)
 **1/2" NPT fitting – Not recommended for ranges above 6,000 psig.

Process - 4 1/2" Series 25 ABS Case



Test - 4 1/2" Series 25 ABS Case



How To Order:

To obtain your part number for the type of gauges you need, select on variation under each column heading. Place a check mark immediately below the part number for each variation. When complete, write the part number above each check. The resulting number is your part number. (Note: The first two numbers are always 24 or 25 as indicated.) Example: 25544-31B13. For ISO and Metric scales add suffix to the end of number

ISO and Metric Scale	
Type	Suffix
kilopascals/megapascals*	ISO
BAR	ISB
kg/cm ²	ISK





Note: for dual scale add 'D' to suffix ie; psi & bar = ISBD. PSI are typically on outer arc.
*Above 1000 PSI

RS380-1 Filter. The RS380-1 Filter is standard equipment on all 3D gauges to prevent particles from entering the bourdon coil. Made of 300 series stainless steel for corrosion resistance, RS380-1 is easily removed for cleaning. Filters are available separately and should be replaced regularly if media has particles.

Custom dial faces. 3D's design and engineering department can provide special dial to customers' specifications upon request. Customized faces may show forces or weight, extended ranges, special color, corporate logo-type, or legends.

Max Pressure Pointer. A "Dead Hand" pointer is moved by the gauges indicating pointer on increasing pressure, and the "Dead Hand" pointer remains at maximum pressure when the gauges pressure returns to normal or zero. The gauges pressure returns to normal or zero. The assembly is mounted on the gauge crystal and has an external reset knob to reposition the pointer. This pointer is available on the 4 1/2", 6", 8 1/2" and 12 inch gauges. (Max Pressure pointer may move when used in Shock or vibration applications). Add "GAV" to the end of the part number.

Other Direct Drive Difference Pressure Gauges

STAINLESS STEEL	SANITARY	REFRIGERATION	RECEIVER
<ul style="list-style-type: none"> "Direct Drive" technology – 6 year warranty!! 300 series SS case - 2 1/2" and 4 1/2" dial sizes Pressure ranges to 20,000 psi Optional mounting flanges 	<ul style="list-style-type: none"> "Direct Drive" technology – 6 year warranty!!* 1 1/2" or 2" 316L SS Ladish Tri-Clamp seal 300 Series SS case – 2 1/2" and 4 1/2" dial sizes 1% of full scale or better accuracy for many ranges Pressure ranges to 1500 psi; compound available 	<ul style="list-style-type: none"> "Direct Drive" technology – 6 year warranty!! ABS, Valox Turret and SS cases available Field adjustable fitting on 4 1/2" ABS & Valox versions Various refrigerant versions 	<ul style="list-style-type: none"> "Direct Drive" technology – 6 year warranty!! 2 1/2", 4 1/2" and 6" dial sizes 3-15 psi and 3-27 psi versions Many dial scale units are available Field adjustable fitting on 4 1/2" version 

Refer to 3D Document: KT-013 Refer to 3D Document: KT-091 * Seal & Fill have 1 year warranty Refer to 3D Document: KT-096 Refer to 3D Document: KT-015