

# Ultrasonic Flow meter quick start guide

## Model: P118i



We also have an installation demo video on Youtube  
Search for 'pFlow P118i Flow meter demo', scan the QR code, or use the below link

<https://youtu.be/pOBFiaU8sIU>



---

# Contents

Introduction: .....	3
Keypad functions.....	4
Select installation location.....	5
Transducer mounting methods.....	7
Parameters setting.....	8
Pipe preparation .....	11
Transducer installation and fixing.....	12
Orienting the transducers and mounting frames:.....	12
Connecting the transducer cables .....	15
Checking signal strength .....	16
View the flow rate measurement.....	16
Changing the units.....	16
Reset the totaliser.....	16
Data logging .....	17
To begin data logging.....	17
To retrieve logged data.....	18
Basic Troubleshooting.....	20
Frequently asked Questions and Answers.....	21

## Introduction:



Please note that this guide will go through basic functions of the flow meter only, for advance functions please see the full manual.

Open the hinged top cover of the flow meter, the wiring ports of the P118i are shown in the diagram below:

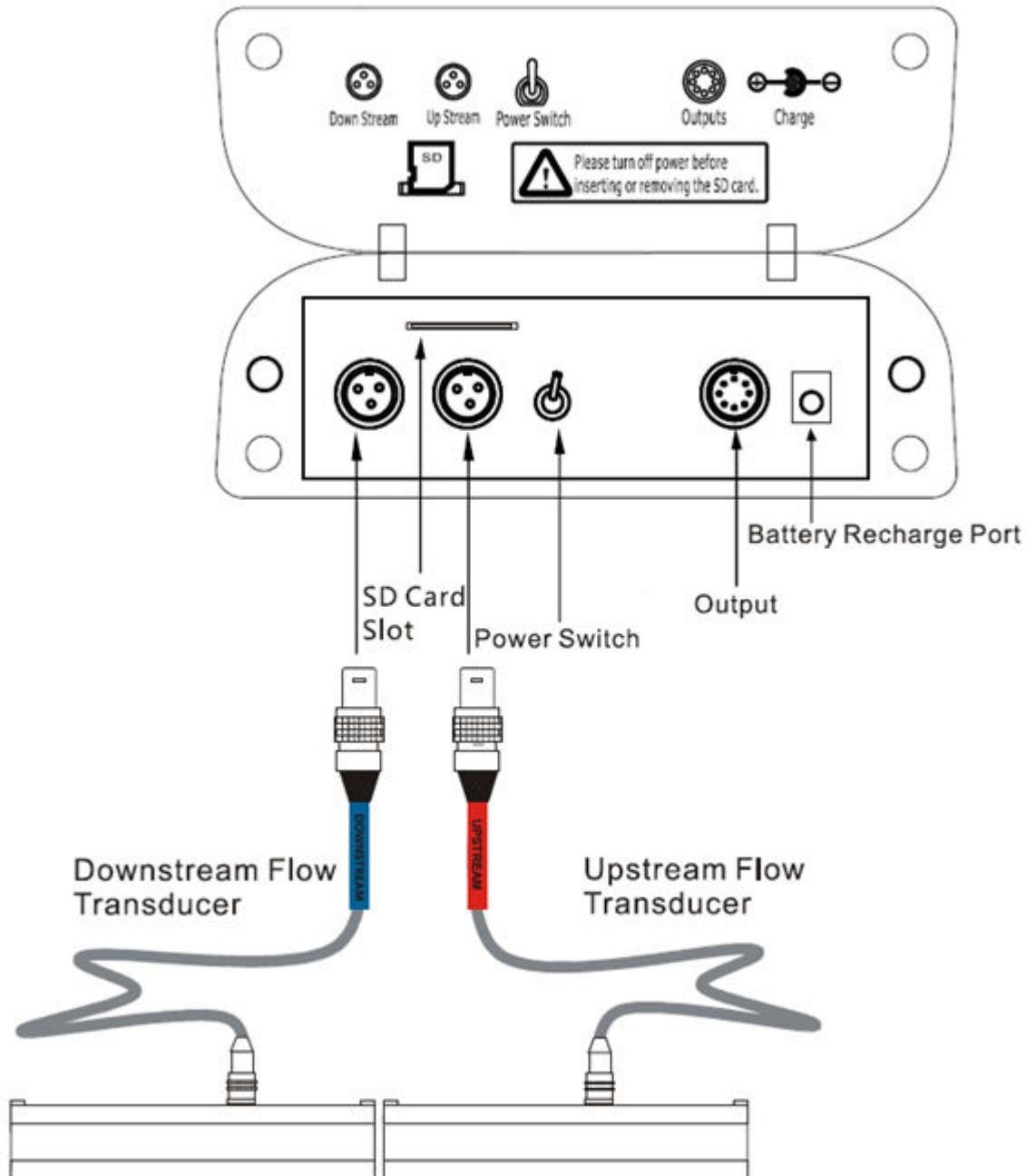

Turn on the power switch at the top of the meter, then you can proceed with using the flow meter. If it does not turn on it may need to be charged before use.

# Keypad functions

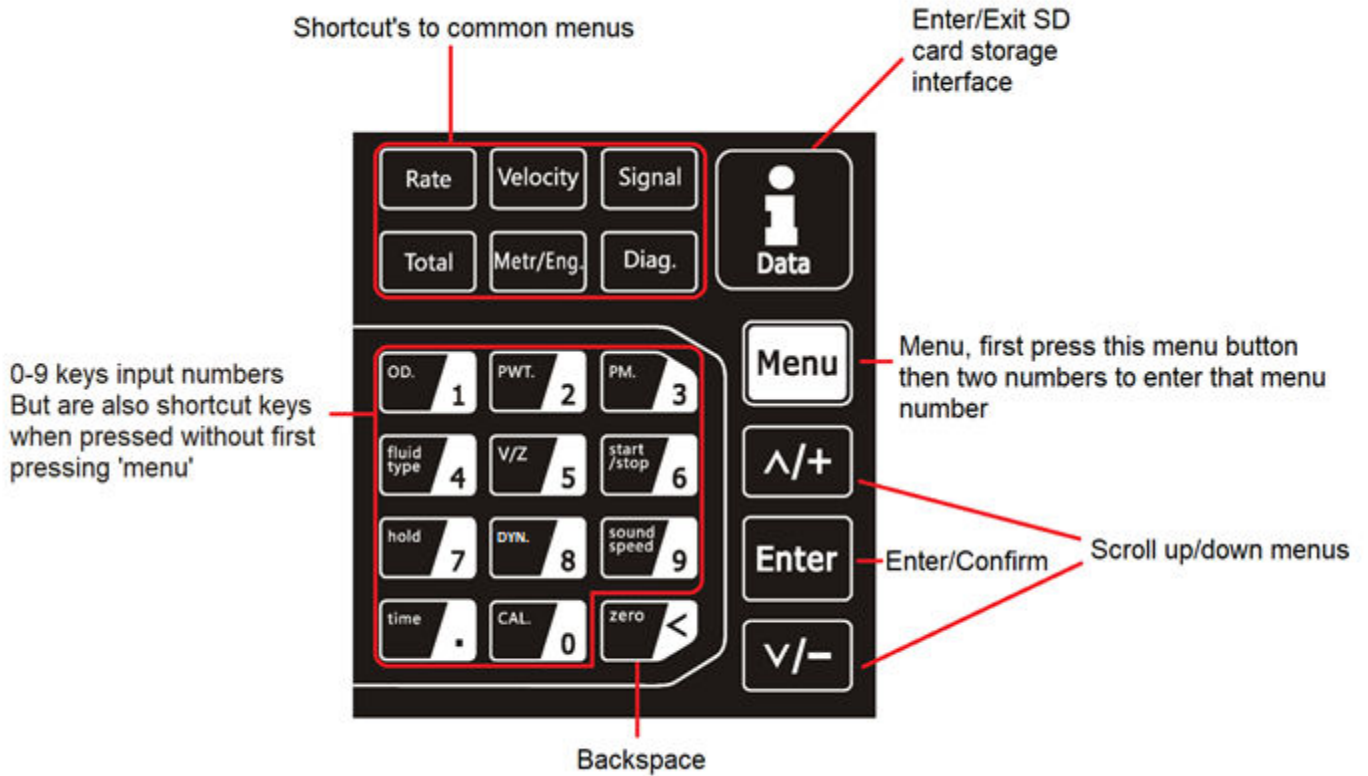

The full keypad is pictured below, this will describe basic functionality of the keypad.



0 – 9 keys input numbers, each word printed on the key also is a shortcut to that menu

 is also used as a decimal place button

 is also used as a backspace

 and  scrolls up and down menu numbers

### The enter a specific menu:

press the  button, then input a two-digit Menu number.

for example, by pressing these buttons:    will enter menu 11

 is enter/confirm

 enter/exist SD card storage interface

## Select installation location

Measurements cannot be made accurately if pipe is not filled, install transducers in a position that is filled with fluid, even after flow has stopped. Some below examples show areas that would be unsuitable for installation.

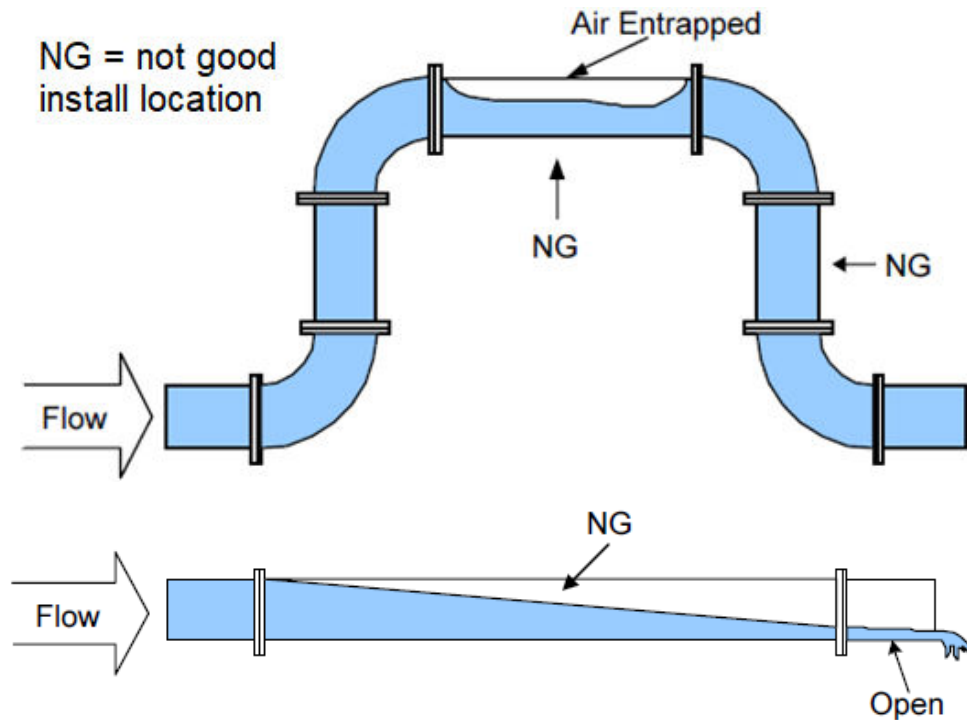

### Sediment

Sediment accumulation at the transducer position may cause measurement errors. Countermeasures include installation of closing flange, etc.

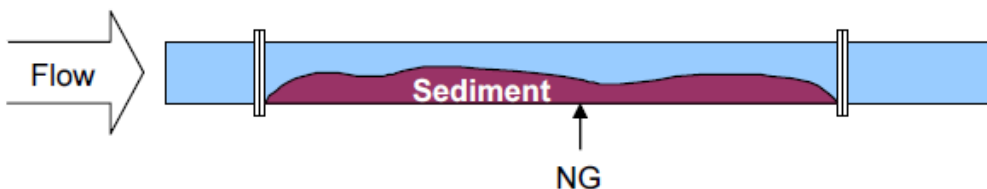

### Entrained air

Measurement may not be possible if there is entrained air at the transducer position.

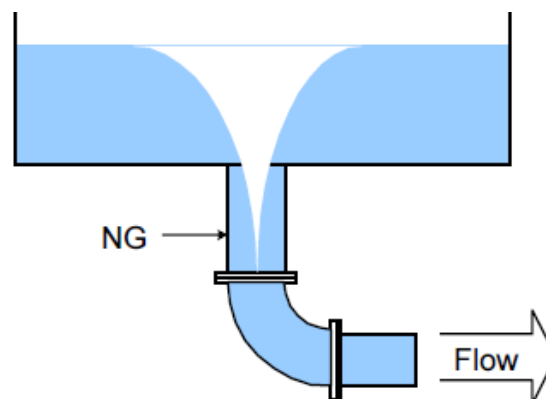

### Vertical pipes

If installing on vertical pipes, it should not be used where flow direction is downward, as the pipe may not be completely full, it would work best on a vertical pipe where the flow direction is from bottom to top.

When selecting a measurement site, it is important to select an area where the fluid flow profile is fully developed to provide an accurate measurement. Use the following guidelines to select a proper installation site

a) Choose a section of pipe that is always full of liquid, such as a vertical pipe with flow in the upward direction, or a full horizontal pipe.

b) Ensure enough straight pipe length before and after the transducers so that the flow is non turbulent inside the pipe

c) Transducers should be mounted on the 3 or 9 o'clock position of the pipe section (at the side of the pipe) this is to avoid sediment at the bottom of a pipe or air bubbles at the top

d) Ensure that the pipe surface temperature at the measuring point is within the transducer temperature limits

e) Consider the condition of the pipe inside and out. Select a section free of excessive corrosion or scaling

f) Consider the possibility of sedimentation at the bottom of the pipe and the presence of an air pocket at the top of the pipe. In addition, avoid flanges and welding areas and select a smooth portion of the pipe to install the transducers.

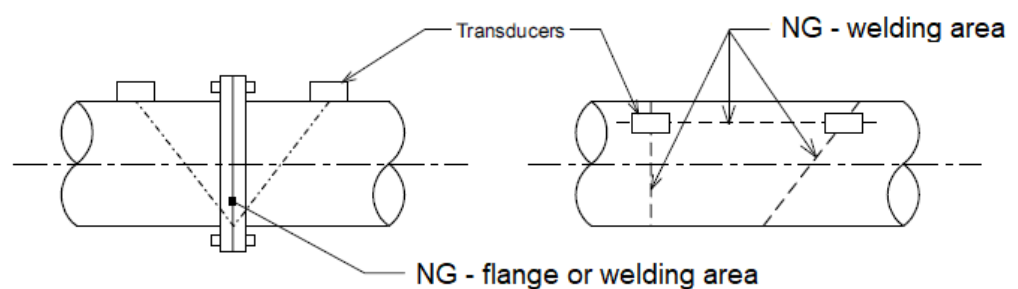
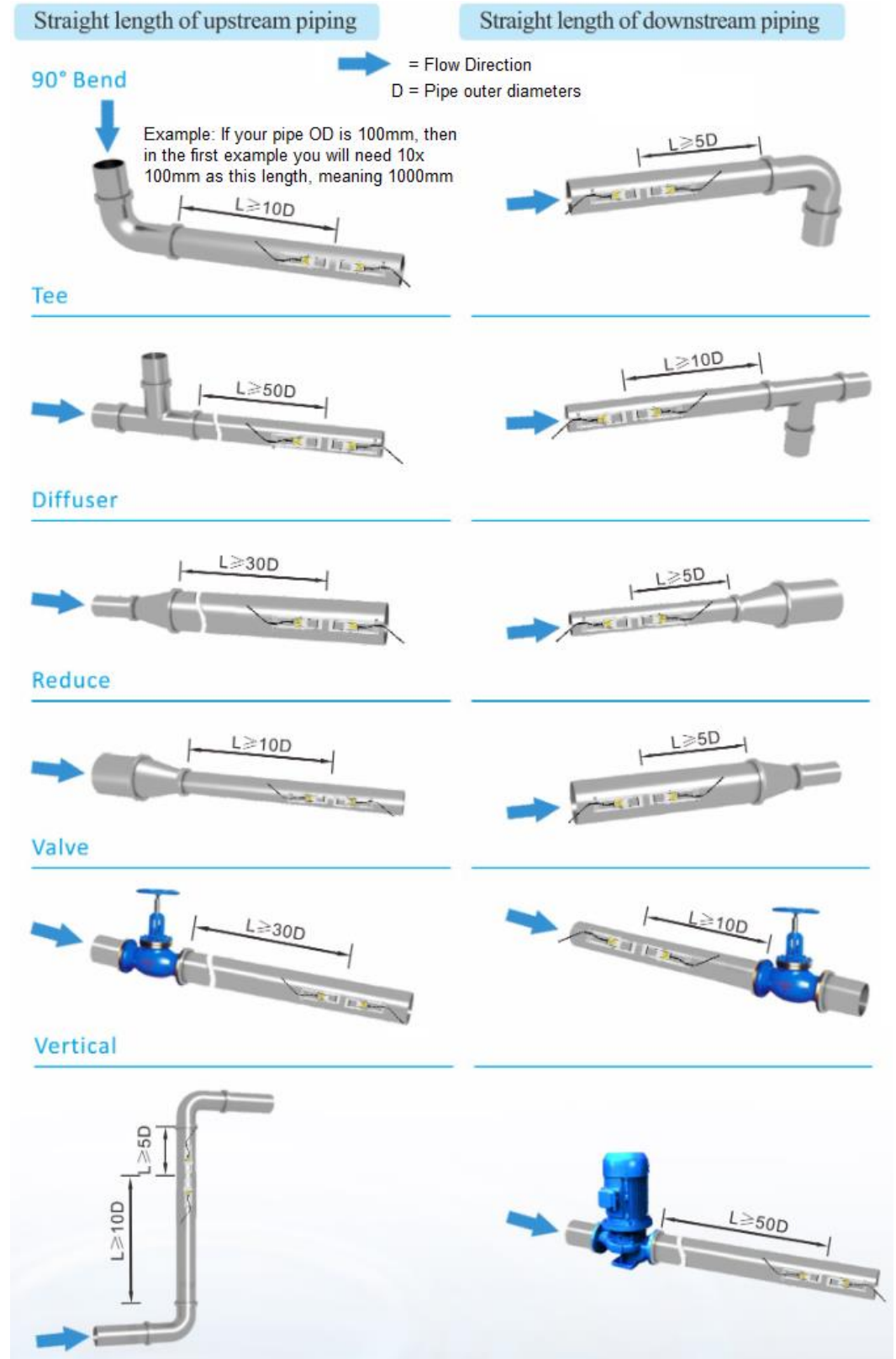

# Transducer mounting methods

Three transducer mounting methods are available, **V method**, **Z method** and **N method**.

## V method

The V method is considered the standard method. It usually gives a more accurate reading and is used on pipe diameters ranging from 25mm to 400mm. It is also the most convenient to use and setup.

V method – can be used for 25mm to 400mm pipes

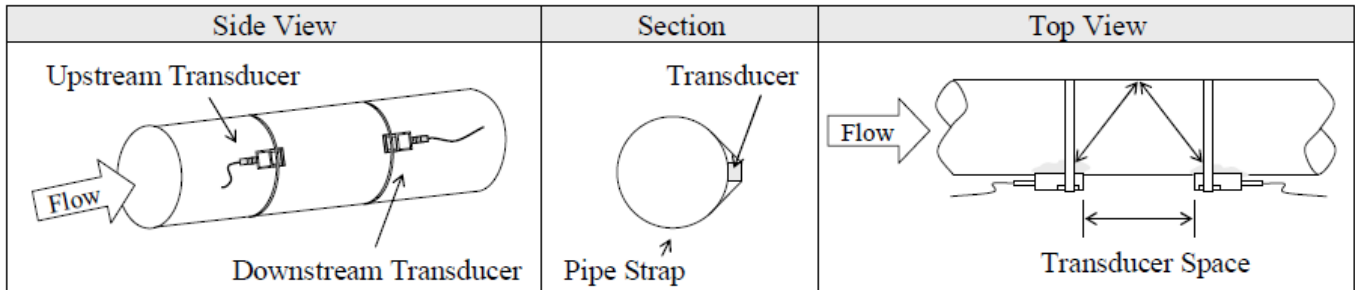

## Z Method

The signal transmitted in a Z method installation has less attenuation than a signal transmitted with the V method, therefore is good to use when the pipes are large, there are some suspended solid in the fluid, or the scaling and liner are too thick. This is because the Z method utilizes a directly transmitted (rather than reflected) signal which transverses the liquid only once. While the Z method can measure on pipe diameters over 100mm, it is recommended to use this method for pipe diameters over 300mm.

Z method – can be used on pipes over 100mm

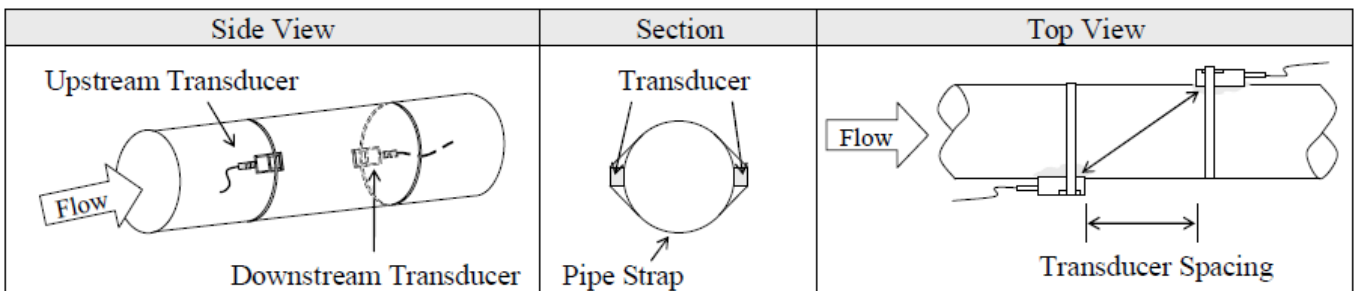

## N Method (uncommonly used)

With the N method, the sound waves traverse the fluid three times and bounce twice off the pipe walls. It is suitable for small pipe diameter measurement. The measurement accuracy can be improved by extending the transit distance with the N method which this helps to achieve on small pipes

N method – while uncommon – it can be used on small pipes usually under 50mm

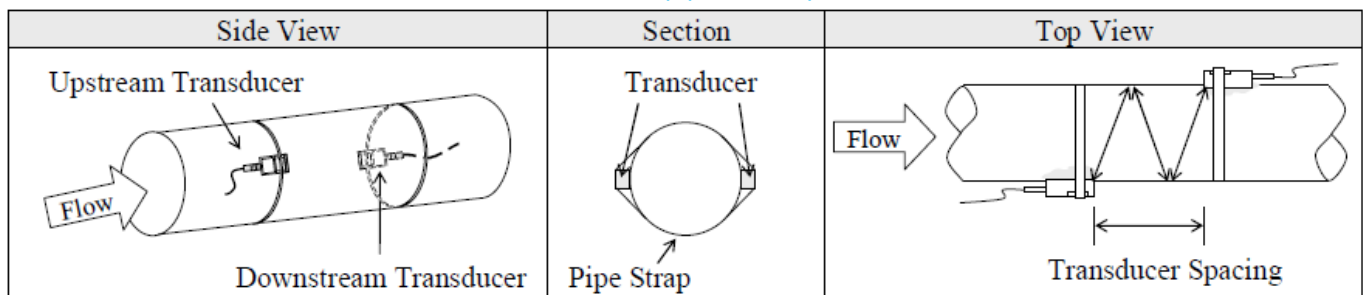

# Parameters setting



This guide will only tell you about the most basic menu's – for a full description about each menu's function please see the full manual

Now that we have decided on a suitable installation location, and by now you should select the best mounting method for your pipe, we will need to program the pipes parameters into the flow meter, follow the below steps

## Pipe outer diameter (Menu 11)

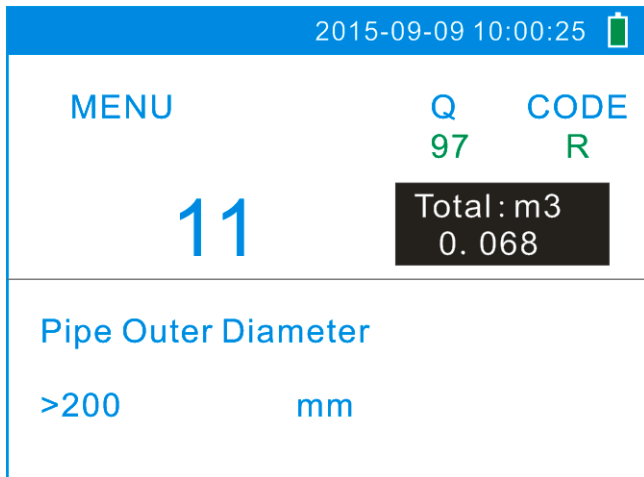

first press  shortcut, or press    to enter menu 11, it will appear as below:



You will now need to change the pipe outer diameter to match your pipe, for example if your pipe was 90mm OD then do the following:



Enter first, then type the diameter '90', then enter again to confirm -

Hint:  and  scrolls up and down menu numbers, so as the next menu of importance is 12, using this is a quick method to change to that menu

## Pipe Wall Thickness (Menu 12)

First press  shortcut, or press    to enter menu 12

You will now need to change the pipe wall thickness to match your pipe, for example if your pipe was 5.2mm then do the following:



Enter first, then type the thickness '5.2', then enter again to confirm -



## Pipe material (Menu 14)

First press  shortcut, or press    to enter menu 14

You can select from the preconfigured materials: carbon steel, stainless steel, cast iron, ductile iron, copper, PVC, aluminium, asbestos, fiber glass epoxy, other



To select your material first press 





then  or  to scroll up and down selectable options, then  again to confirm

Hint: If your material is not one of those listed, please select 'other' here, then you will see if you go to menu 15 you can manually enter the pipe sound velocity which you can check back of the full manual for some other common material sound velocities, or you may be able to find your pipe material's sound velocity with a web search.

### **Pipe liner material (Menu 16)**

Press    to enter menu 16

If your pipe has a liner it must be entered here

 then  or  to scroll up and down selectable options, then  again to confirm

If your pipe does not have a liner, select '0. None'





Hint: If your material is not one of those listed, please select 'other' here, then you will see if you go to menu 17 you can manually enter the liner sound velocity which you can check back of the full manual for some other common material sound velocities, or you may be able to find your material's sound velocity with a web search.

### **Liner Thickness (Menu 18)**

Hint: If you do not have a liner in your pipe, you can skip this, this menu will not be available if no material was selected on menu 16.



Press    to enter menu 18

Only If applicable, enter the thickness of your pipe liner here, for example if your liner thickness is 5.2mm then do the following:

Enter first, then type the thickness '5.2', then enter again to confirm -     

### **Fluid type (Menu 20)**

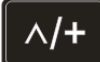
First press  shortcut, or press    to enter menu 20

 then  or  to scroll up and down selectable options, then  again to confirm

You can select from the preconfigured liquids: water, sea water, kerosene, gasoline, fuel oil, crude oil, propane, butane, other, diesel oil, castor oil, peanut oil, gasoline #90, gasoline #93, alcohol, water 125.

Hint: If your liquid is not one of those listed, please select 'other' here, then you will see if you go to menu 21 you can manually enter the fluid sound velocity which you can check back of the full manual for some other common fluid sound velocities or you may be able to find your fluid sound velocity with a web search.

### **Transducer type (Menu 23)**

This should remain set as 0. Standard unless otherwise directed

## Transducer mounting (Menu 24)

Press  shortcut, or press    to enter menu 24





See page 7 (Transducer mounting methods) for more info on selecting the best mounting method, three mounting methods are available

**V** – most common, can be used for 25mm to 400mm pipes

**Z** - can be used if the signal is poor, best used on pipes over 100mm

**N** - while uncommon to use this, it can be used on small pipes usually under 50mm

Select the mounting method

 then  or  to scroll up and down selectable options, then  again to confirm

## Transducer spacing (Menu 25)

Press    to enter menu 25

After setting all the relevant parameters previously, this menu will display the distance that the transducers should be spaced apart.

Install the transducer according to the displayed transducer mounting spacing and the selected mounting method, so in this shown example you need to space them 131.82mm apart.

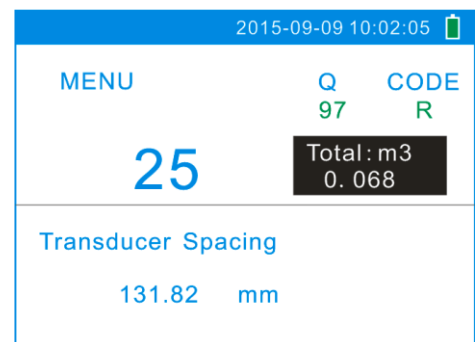

## Pipe preparation

This carries on from page 5 and 6 of selecting an installation location, so by now you should have already selected the ideal location to install the flow meter transducers.

Remember to consider the possibility of sedimentation at the bottom of the pipe and the presence of an air pocket at the top of the pipe.

Because of this it is best to install the transducers on the side of the pipe usually within  $45^\circ$  of a horizontal pipe, as shown.

In addition, avoid flanges and welding areas and select a smooth portion of the pipe to install the transducers.

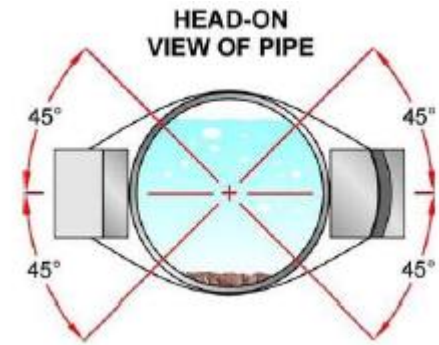

Now that you know how far to space the transducers apart from the previous step, and you have selected a suitable location for the installation with enough distance upstream and downstream away from bends, pumps, valves etc... you can prepare the pipe for mounting the transducers.

Using a polisher or sandpaper make the mounting position clean of all rust, mud, scale, painting etc.

Ensure the polished area is larger than transducer surface area.



Polish one mounting area first. Then input proper parameters in M11 to M24, M25 will display the mounting distance value and then you can polish the other area accordingly.

A clean, polished mounting surface is very important for good signal.

For plastic pipe, clean it of painting, sticky oil, adhesives, etc.



# Transducer installation and fixing



**Note that different versions of transducers and frames are available for this model, your transducers and mounting frames may look different, but the overall premise is the same.**

Now the transducers can be installed onto the pipe, the frames themselves are magnetic so will stick straight onto magnetic pipes, or you can use pipe straps to attach them to other pipes such as PVC.

The mounting conditions and positioning directly influences the flow value accuracy and system long-term operation reliability so it is important to mount the transducers correctly and accurately.

## Orienting the transducers and mounting frames:

On each mounting frame it has a marking for upstream on one of them and downstream on the other, there is also an arrow showing flow direction.



On each transducer you will also see an upstream or downstream marking to ensure it is in the relevant frame.



Also note that when looking at the bottom of the frames in when in the correct orientation, the brown oval which is the sensing surface should be facing each other like below picture when used in V method.



After setting all the previous correct parameters, space the transducers as per the distance on menu 25



This guide will demonstrate the basic and most common V method mounting. If using Z or N method please see the full manual for a full description.



For example, if your menu 25 says to space it at 80mm then put the transducers like this, 40mm from the end of each frame to make a total of 80mm between transducers

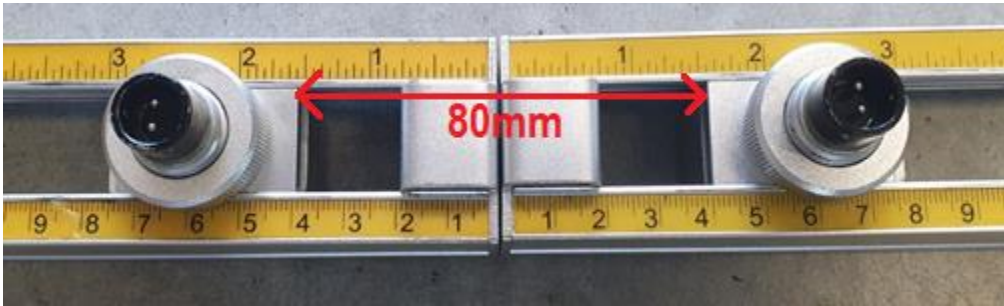

Then the total frame together is ready to be mounted:



Apply couplant to both transducer sensing surfaces, like in the below example:

Silicone-based grease can be used as an acoustic couplant, when selecting a grease ensure to select one that is rated not to “flow” at the temperature that the pipe may reach. We use ‘Super Lube Multipurpose synthetic grease’



Place the mounting frames on the pipe ensuring the distance between sensors remains matching the distance stated on Menu 25

Also ensure that the transducers themselves are placed in the area you prepared by polishing in the earlier steps.



Rotate the transducer mount which is spring loaded to ensure the transducer is firm up against the pipe. This rotary knob moves the transducer in and out within the frame for a snug fit.

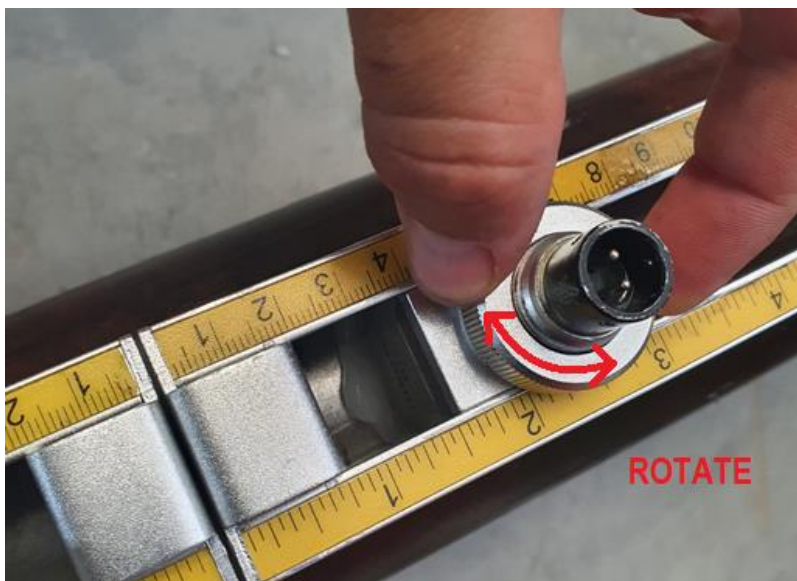

If you are installing the frames on a non-magnetic pipe, then you can use the pipe straps to attach the frames to the pipe, as shown below:

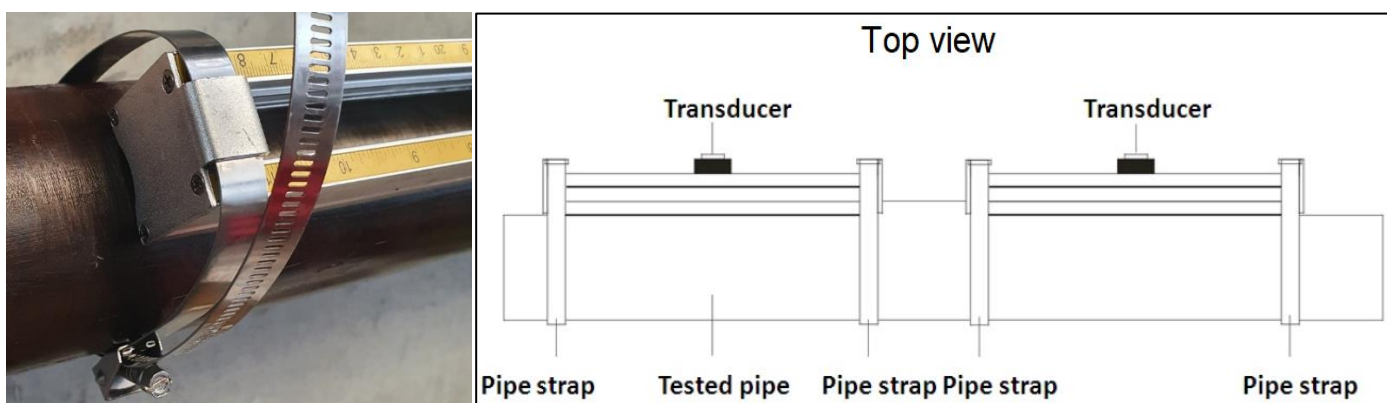

Hint: in some situations, it might be easier for you to use only one frame, you could remove one transducer and place it into the other frame with it if you will always be using V method on small pipes

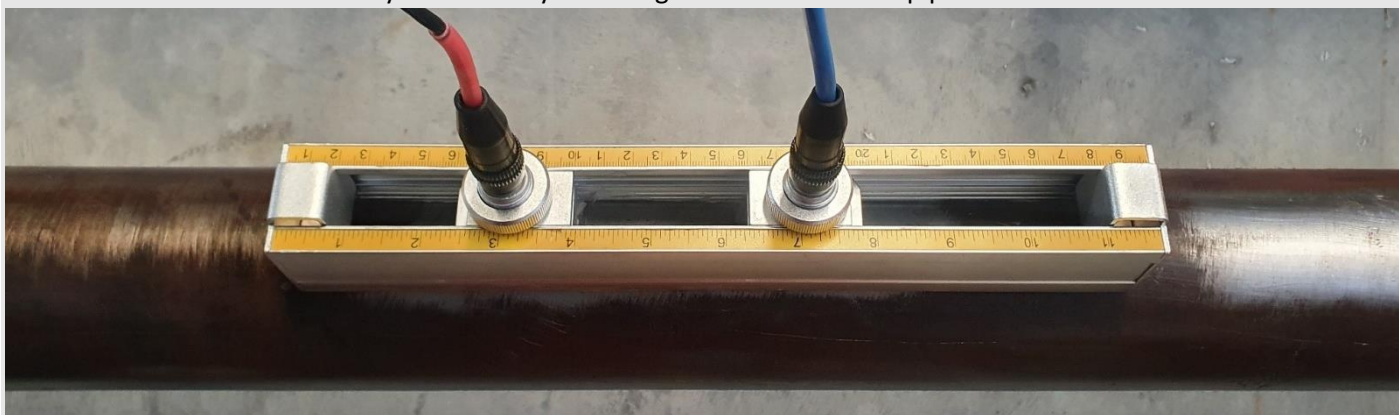

---

## Connecting the transducer cables

Now connect the transducer cables as shown below – ensure you have upstream and downstream in the correct position – if wired backwards the signal and reading will be 0.

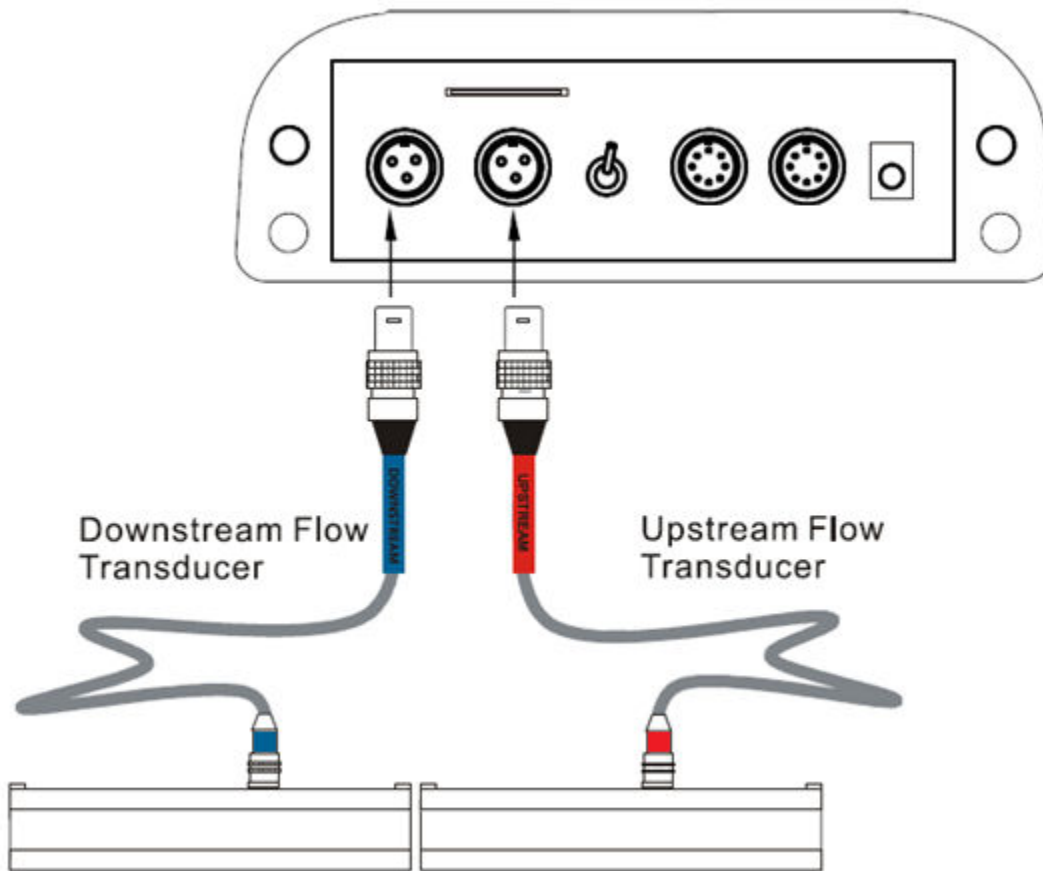

Now the meter should begin reading, there are a few values you should check to ensure proper installation as per the next section.

# Checking signal strength

## Check Signal strength (Menu 90)

Press  shortcut or press    to enter menu 90

Signal strength indicates a detected strength of the signal both from upstream and downstream directions.

The relevant signal strength is indicated by numbers from 00.0 – 99.9

00.0 represents no signal detected while 99.9 represents maximum signal strength. The stronger the signal strength detected, the better the instrument reliability will be. It will also result in a more stable measurement value.

Ensure all the previous setup steps have been carried out and ensure enough couplant has been applied. Adjust the transducer position during the installation to obtain the maximum signal strength.

Normal system operation **requires signal strength over 65.0** from both upstream and downstream directions. If the signal strength detected is too low, the transducer installation position and the transducer mounting spacing should be re-adjusted and the pipe should be re-inspected. If necessary, re-consider the mounting method of Menu 24 or you can also check the troubleshooting steps outlined in the troubleshooting section.

## Transit time ratio (Menu 91)

Enter the transit time menu by pressing    to enter menu 91

Transit time ratio indicates if the transducer mounting spacing is accurate. The **normal transit time ratio should be 100±3** if the installation and parameters and been completed correctly.

If the transit time ratio is over 100±3 it is necessary to check:

- If the parameters are entered correctly (pipe outside diameter, wall thickness, pipe material, liner, etc.)
- If the transducer mounting spacing is in accordance with the display in Window M25
- If the transducers are mounted correctly
- If the scale is too thick or the pipe mounting is distorted in shape, etc.
- You can also check the troubleshooting steps outlined in the troubleshooting section

## View the flow rate measurement

To view your flow rate measurement, press the  shortcut.

It will display the flow rate and the totaliser values  
(Totaliser is total amount of liquid flowed since last reset)

### Changing the units

Flow rate unit can be changed on menu 31





Totaliser unit can be changed on Menu 32

### Reset the totaliser

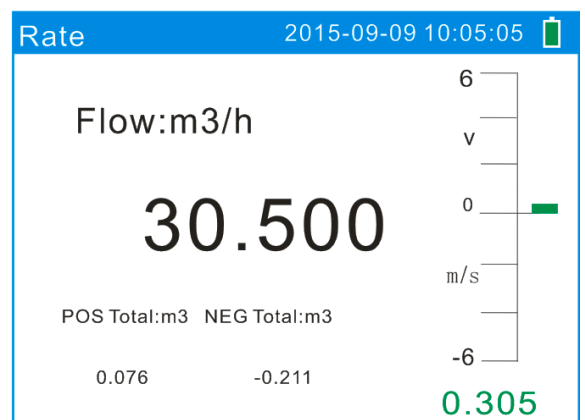
To reset the totaliser back to 0, go to Menu 37

It shows: "Totalizer Reset?"



Press  then  or  to scroll up and down selectable options, then  again to confirm



# Data logging



Be aware when the capacity of the SD card is full, new data will overwrite old data automatically. Though the files are small so it would take a while to fill the SD card.

**Data collection interval:** Interval time is how often the unit will take a log, any interval setting from 1 to 60 seconds is acceptable. If the rate is set longer than 60 seconds the default will be 1 second.

**Data collection time:** Collection time is how long the unit will perform logging for. It is user selectable from 1~9999 mins. If it is set longer than 9999 mins, it will default to 9999 mins.

**Data content:** date and time, flow rate, flow velocity, total flow, positive totalizer, and negative totalizer.

## To begin data logging

first ensure the SD card is correctly installed



Press the  button to enter the SD card storage setting interface which will appear as pictured:

You can choose to specify a file name, collection time and interval time

When you are ready to begin logging, ensure the 'Start' button

is highlighted using the  and  buttons, then press  to start logging.

Notice that a graph will appear showing the logging process, also in the bottom left the time will be incrementing.

When the collection time has finished it will stop logging, or you can manually stop the logging by highlighting the 'Stop' button on the display, then pressing the enter key.

When it has finished logging the word 'stop' will change to 'start', you can scroll down and press OK to exit the logging graph.

The unit has saved the logged data onto the SD card

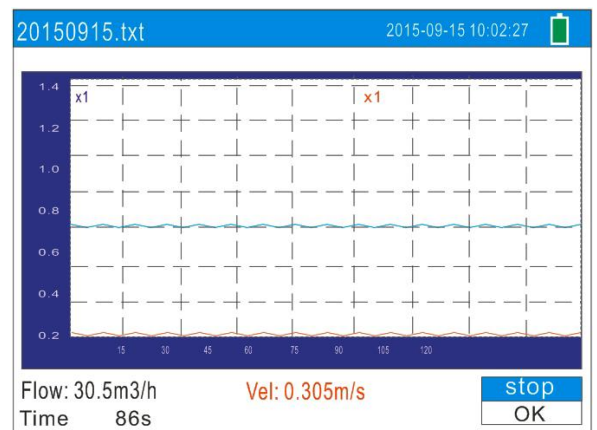
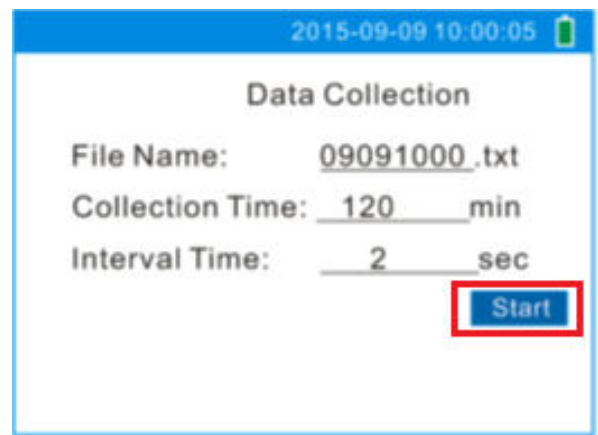

## To retrieve logged data

Ensure the flow meter is turned off, remove the SD card from the flow meter (it is in the top panel)

Using the included SD card reader, insert the SD card into the reader, then insert the card reader into a USB port on a Microsoft windows-based computer.

On the included software disk, run the software called Converter.exe. (It may also be on the SD card) or contact us for a copy of this software if required.

First press the 'Offline' button

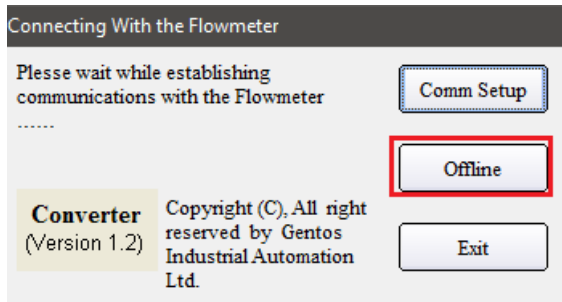

Press the button to select a source file, which is .txt format

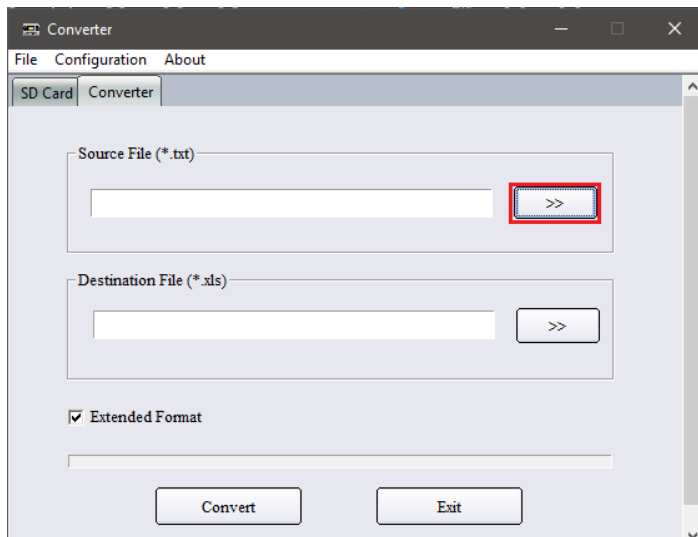

This prompt will appear, navigate to the SD card folder and you will find your logged data in .txt files  
Select the one you want to convert, then press Open

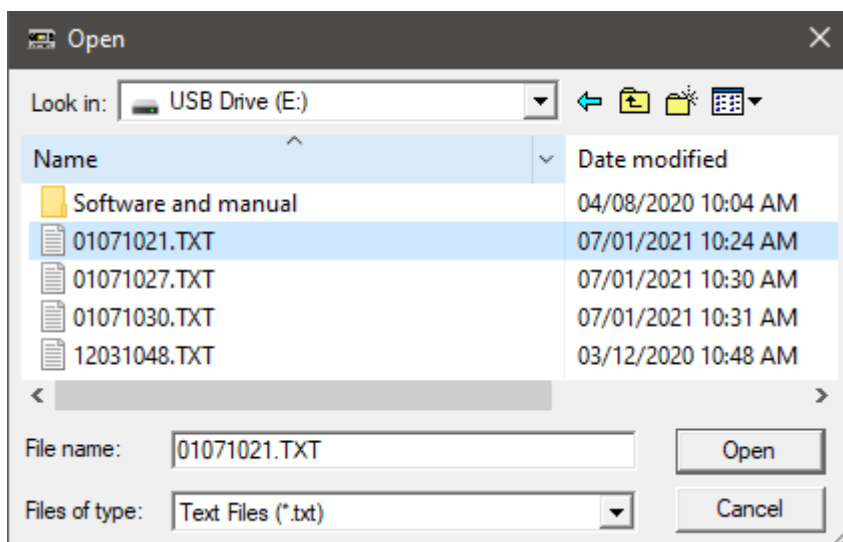

Note the destination location that it will save to, or you can manually select a location, now press 'Convert'

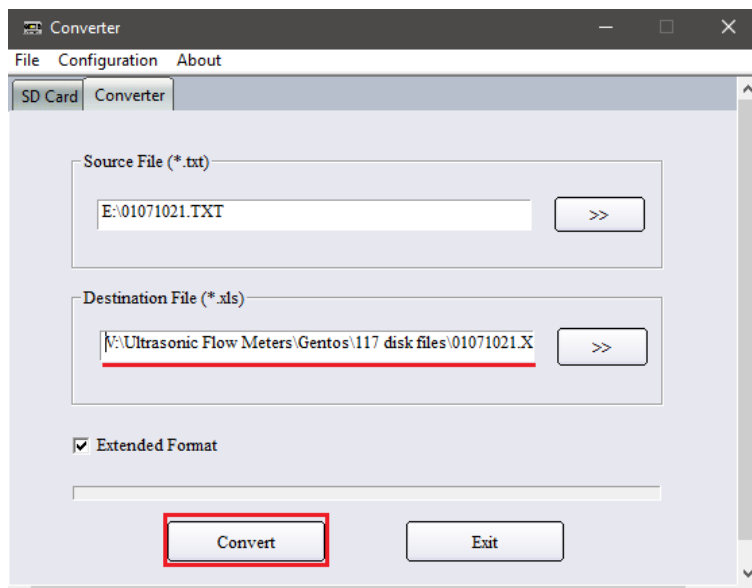

It will convert the file into an .xls file, open the newly converted file and you will see your logged data.

	A	B	C	D	E	F
1	Time(HH:MM:SS)	Flow(m3/h)	Velo(m/s)	Net(m3)	Pos(m3)	Neg(m3)
2	10:48:26	8.45058	0.02788	2747.772	2747.772	0
3	10:48:28	8.82509	0.02912	2747.974	2747.974	0
4	10:48:30	9.01961	0.02976	2748.389	2748.389	0
5	10:48:32	9.10424	0.03004	2748.631	2748.631	0
6	10:48:34	9.16942	0.03025	2748.875	2748.875	0
7	10:48:36	8.96669	0.02958	2749.3	2749.3	0
8	10:48:38	8.82179	0.0291	2749.508	2749.508	0
9	10:48:40	8.64198	0.02851	2749.741	2749.741	0

---

# Basic Troubleshooting

## **If you are having problems acquiring or maintaining strong signal over 65**

- Pipe parameters entered must be accurate; otherwise, the flowmeter will not work properly.
- During the installation, apply enough coupling compounds to the transducer to ensure adequate contact with the pipe wall.
- Check to be sure the mounting spacing is accordance with the display in Menu 25 and the transducer is mounted at the pipe's centreline.
- While checking the signal strength and Q value, if required you can move the transducers slowly around the mounting site until the strongest signal and maximum Q value can be obtained.
- Ensure the pipe surface is sanded/polished and free from dirt where the transducers are mounted.
- Keep the flowmeter away from the electromagnetic interference area to ensure its proper operation. Heavy vibrations on a pipe can also cause issues.
- Ascertain there is not too much air or solids in the fluid, etc.
- if there is still none or poor signal detected, the measurement site must be changed.

## **If the signal strength is always displayed as 0.00 there is no signal detected.**

- Check that the parameters have been entered accurately.
- Check to be sure the transducer mounting method has been selected properly, the pipe is not worn-out, and the liner is not too thick.
- Make sure there is indeed fluid in the pipe, or the transducer is not too close to a valve or elbow
- Make sure the cables are connected correctly, and to the correct upstream/downstream ports
- Make sure the transducers are correctly mating to the pipe surface and all in the correct orientation.

## **If signal strength value Q displayed in M90 is less than 65, following methods are recommended:**

- Relocate a better location noting the recommendations on page 6.
- Try to polish the outer surface of the pipe and use enough coupling compound to increase the signal strength.
- The transducers spacing should be the same as M25 value, you can try to adjust the position slightly to increase signal.
- If you have the unit on charge, please try without the charger inserted, sometimes the charger can cause some electronic interference.
- You can also try another mounting method instead, V mounting method is most common to use, however it requires the signal to "bounce" off the pipe and therefor can degrade the signal or if the pipe is pitted slightly the signal may bounce unreliably. If you instead use Z method for example the transducers are mounted on opposite sides of the pipe and therefor no "bouncing" is required and should provide a stronger signal when setup correctly.



You may need to reference the full manual for further installation instructions.

---

## Frequently asked Questions and Answers

**Question:** New pipe, high quality material, and all installation requirements met: why still no signal detected?

**Answer:** Check pipe parameter settings, installation method and wiring connections. Confirm if the coupling compound is applied adequately, the pipe is full of liquid, transducer spacing agrees with the screen readings and the transducers are installed in the right direction.

---

**Question:** Old pipe with heavy scale inside, no signal or poor signal detected: how can it be resolved?

**Answer:** Check if the pipe is full of fluid. Try the Z method for transducer installation (If the pipe is too close to a wall, or it is necessary to install the transducers on a vertical or inclined pipe with flow upwards instead of on a horizontal pipe). Carefully select a good pipe section and fully clean it, apply a wide band of coupling compound on each transducer face (bottom) and install the transducer properly. Slowly and slightly move each transducer with respect to each other around the installation point until the maximum signal is detected. Be careful that the new installation location is free of scale inside the pipe and that the pipe is concentric (not distorted) so that the sound waves do not bounce outside of the proposed area.

For pipe with thick scale inside or outside, try to clean the scale off, if it is accessible from the inside. (Note: Sometimes this method might not work, and sound wave transmission is not possible because of a layer of scale between the transducers and pipe inside wall).

---

**Question:** Why is the flow rate still displayed as zero while there is fluid obviously inside the pipe and a symbol of "R" displayed on the screen?

**Answer:** Check to see if "Set Zero" was carried out with fluid flowing inside the pipe (Refer to Window M42) If an incorrect "Set Zero" has been carried out, do it again correctly or recover the factory default in Window M43.

---

**Question:** The pipe is not full of liquid or there is no flow in the pipe, but still displays an unstable or wrong reading?

**Answer:** Pipe must be full of liquid, if not, enter the menu 29 to setup an Empty Pipe Q Value less than normal Q value (pipe is full of liquid), cut off abnormal reading, the flow meter will display zero reading.

---

**Question:** The pipe is full and flowing, but only at a very low speed, why is the flow meter is displaying 0 flow?

**Answer:** The data in M41 is Low Flow cut-off Value. If the flow rate falls below the low flow cut-off value, the flow indication is deemed to be ZERO. This can prevent nuisance readings causing the totaliser to accumulate the flow when the actual flow is "0" after a pump was shut down for example. Generally, 0.03m/s is recommended to enter as the flow cut-off point.

The low flow cut-off value has no relation to the measurement results once the velocity is higher than the flow cut-off value.

---

**Question:** Why is the flow reading on the display not the same as a trusted known flow rate?

**Answer:** If you have a known flow rate on a pipe and this flow meter is not reading as expected then the flow meter may need to be "tared" or "zeroed". Just like scales for example, the zero point sometimes needs to be reset. First, the zero may have accidentally been set to an incorrect point, in which case you can re-set the zero point to the factory point using Menu 43.

Alternatively, if you install the flow meter on a full pipe with no flow you can use Menu 42 to set a new zero point. See the full manual for more information on this.

If the zero point is fine, your flow meter may need re-calibration, it is recommended to have the flow meter calibrated regularly to maintain best accuracy.

---