

Ultrasonic Flowmeter Instruction Manual

Model: D116



pFlow

Update Record	Revision	3.1.1
	Date	08 . 2024

Notice:

This instruction manual is appropriate for D116 series ultrasonic flowmeter.

This ultrasonic flowmeter adopts ARM.kernel chip and low-voltage wide-pulse sending technology.

This instruction manual contains important information. Please read carefully before the operation of the flowmeter, avoiding damaging flowmeter and improper use.

This instruction manual will introduce how to use the flowmeter step-by-step, including product component, installation, wiring, quick setup etc. to make it easier to operate.

Understanding more about the menu settings can fulfill your higher requirements with the flowmeters' powerful function option and output function.

**Warning**

May cause injury.



**Attention**

May damage the flow meter.

Some of the instructions may be different to the flowmeters you purchased, depending on configuration requirements, otherwise, there is no indication about the product design and upgrade requirement in the instructions, subject to the flowmeter display, please refer to the version number, as well as the appendix.

Product Components

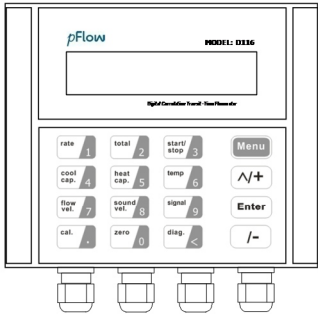
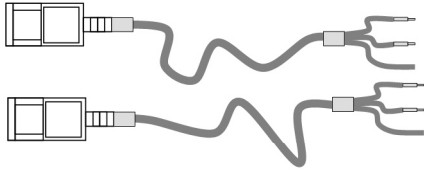
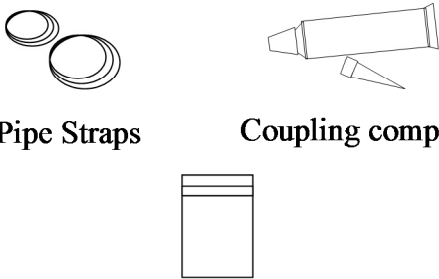
Inspection should be made before installing the Flowmeter. Check to see if the spare parts are in accordance with the packing list. Make sure that there is no damage to the enclosure due to a loose screw or loose wire, or other damage that may have occurred during transportation. Any questions, please contact your representative as soon as possible.

Transmitter	Transducers
	
Accessories	Documents
 <p data-bbox="229 1137 376 1173">Pipe Straps</p> <p data-bbox="475 1137 740 1173">Coupling compound</p> <p data-bbox="344 1330 558 1366">Install accessory</p>	 <ol data-bbox="951 1227 1248 1352" style="list-style-type: none"> 1. Instruction Manual 2. Packing List 3. Position drawing

Content

1	Transmitter Installation and Connection	6
1.1	Inspection prior to Transmitter Installation.....	6
1.2	Wire Connecting	7
1.2.1	Power supply option	7
1.2.2	Transmitter Wiring	7
1.2.3	Lengthened Cable Method.....	7
1.3	Powering on	9
1.4	Keypad Functions.....	9
1.5	Keypad Operation	9
1.6	Flowmeter Window Descriptions.....	10
2	Pipe Parameter Entry Shortcuts	11
2.1	Dual function keys menu description.....	11
2.2	Examples.....	12
3	Measurement Site Selection	14
4	Transducer Installation	15
4.1	Installing the transducers.....	15
4.1.1	Transducer Spacing.....	15
4.1.2	Transducer Mounting Methods.....	15
4.1.3	V Method	15
4.1.4	Z Method	16
4.1.5	N Method (not commonly used).....	16
4.2	Transducer Mounting Inspection.....	16
4.2.1	Signal Strength.....	16
4.2.2	Signal Quality (Q value).....	17
4.2.3	Total Time and Delta Time.....	17
4.2.4	Transit Time Ratio	17
4.2.5	Warnings.....	17
5	Operating Instructions	19
5.1	System Normal Identification	19
5.2	Zero Set Calibration	19
5.3	Scale Factor.....	19
5.4	System Lock.....	19
5.5	Frequency Output.....	20
5.6	4~20mA Current Loop Output Verification (Optional)	20
5.7	Recover the Factory Default	20
5.8	4~20mA Analog Output Calibration.....	21
5.9	ESN.....	21
6	Windows Display Explanations	22

6.1	Windows Display Codes	22
6.2	Display Explanation	23
7	Error Diagnoses.....	36
7.1	Table1. Error codes and solutions	36
7.2	Frequently Asked Questions and Answers.....	37
8	Product Overview	38
8.1	Introduction.....	38
8.2	Features of D116.....	38
8.3	Specifications	39
9	Appendix1-Serial Interface Network Use and Communications Protocol.....	40
9.1	Overview	40
9.2	Direct connection via RS-485 to the host device	40
9.3	Communication protocol and the use.....	40
9.3.1	FUJI Protocol.....	41
9.3.2	MODBUS Communication Protocol	42
10	Appendix2-W211 Insertion Transducer	46
10.1	Overview	46
10.2	Measurement Point Selection.....	46
10.3	Determining Transducer Spacing & Transducer Installation.....	46
10.4	Transducer Mounting Methods	48
10.4.1	Z Mounting Method.....	48
10.4.2	Pipe Parameter Entry Shortcuts	48

Update Information:

1 Transmitter Installation and Connection

1.1 Inspection prior to Transmitter Installation

You will find a "Position Drawing" in the packing. Please use it as a template in the place that you are going to install the Flowmeter. Then drill 4 installing holes at the screws position shown on the drawing with the 5.0mm drill.

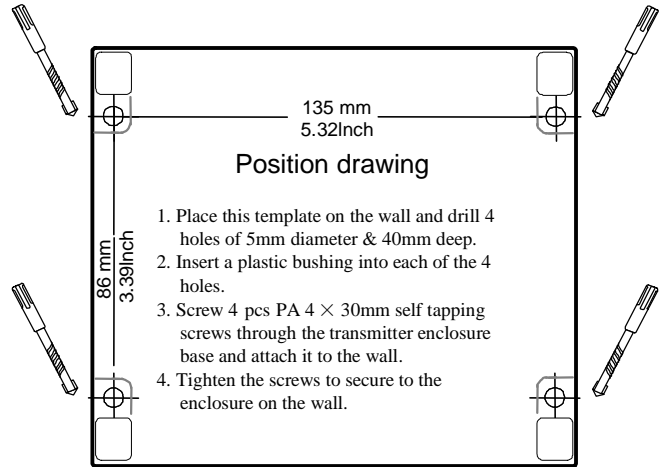

Take out the enclosed screws and plastic bushings. Insert the plastic bushings into the installing holes. Put the flowmeter to the position and screw it in.

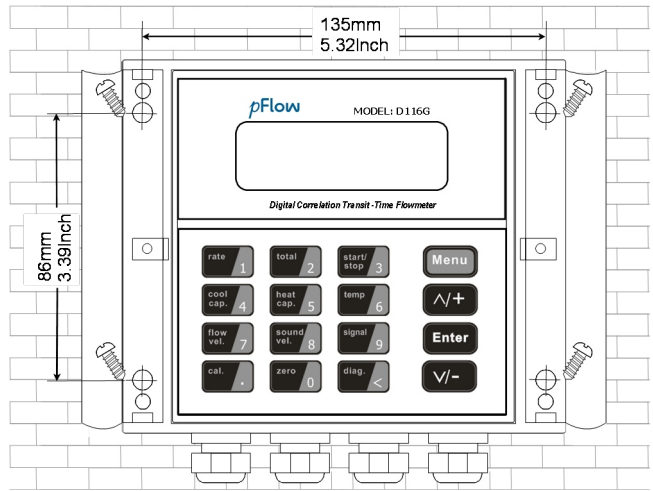

Attention

When installing please ensure the front cover is secure and will not fall open.

1.2 Wire Connecting

1.2.1 Power supply option

Customers should pay special attention to specify the desired power supply when wiring.

Factory standard power supply is 10~36VDC/1A max.

To ensure the transmitter can work normally, please pay attention to the followings when wiring:

Ensure that power connections are made in accordance with the specifications shown on the transmitter.

1.2.2 Transmitter Wiring

Once the electronics enclosure has been installed, the Flowmeter wiring can be connected.

Open the case, you will find the transmitter interfaces labels from left to right as follows:

Power supply, Relay output, OCT Output, Upstream transducer, Downstream transducer, 4-20mA, RS485 interface.

Refer to the below diagram for specific connection:

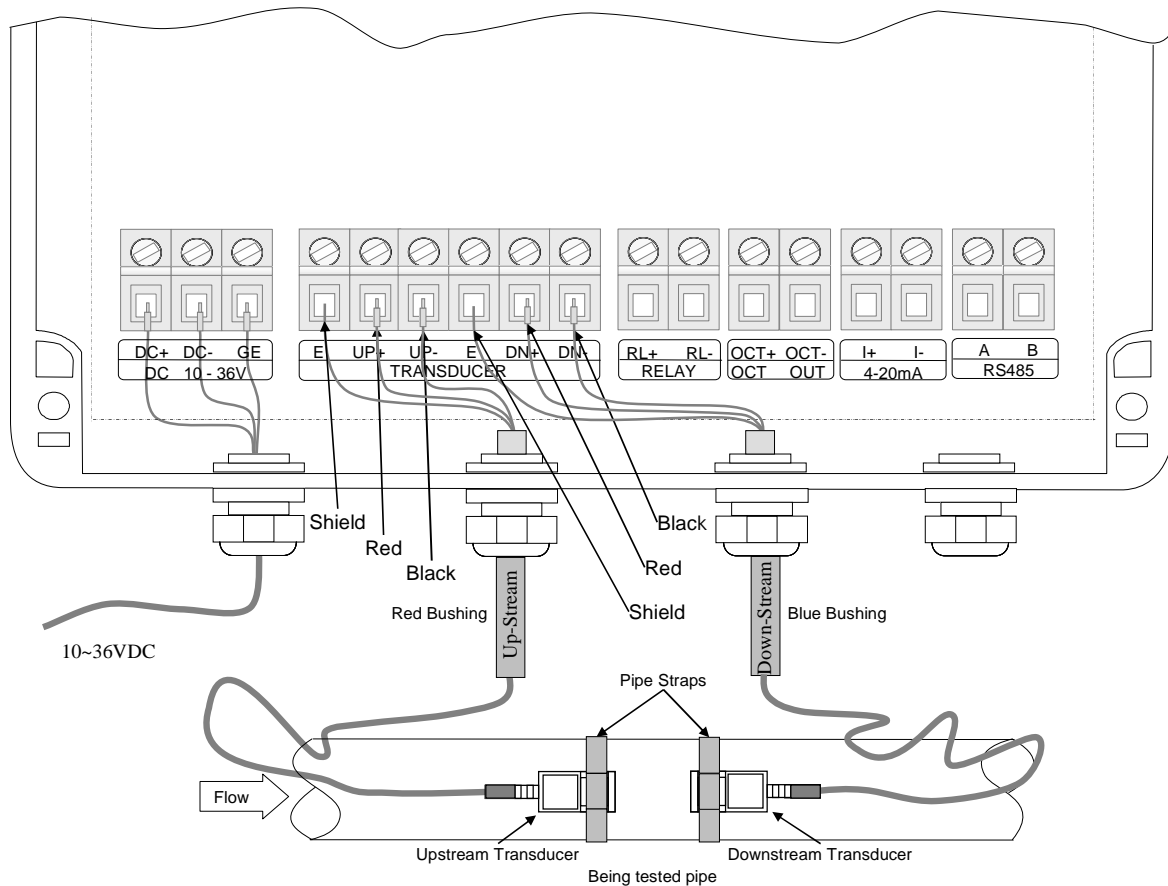

1.2.3 Lengthened Cable Method

Standard cable length of sensor is 9 meters; it can be lengthened to be 300 meters according to the actual need for fluid measurement.

1.2.3.1 Sketch of lengthened Cable

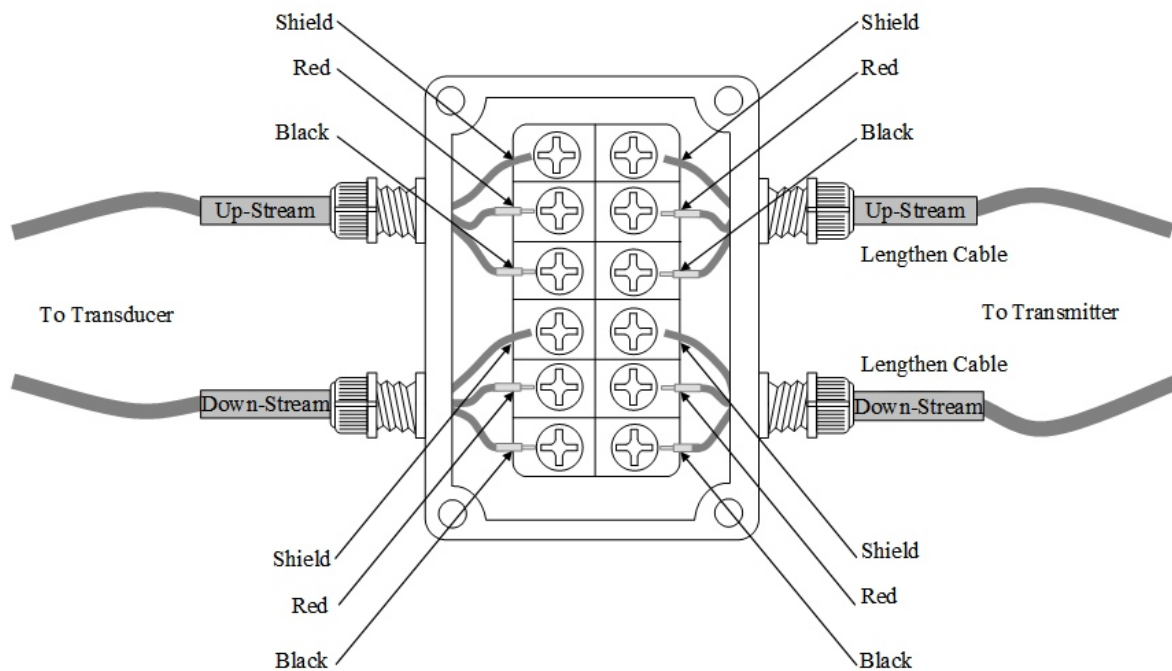

1.2.3.2 Junction Box Requirements

The flowmeter use sealed waterproof junction box, installing 6×2 press-connections, the recommended minimum specifications of the junction box is 115×90×55mm.

1.2.3.3 Cable Specifications

Name: Shielded Twisted Pair

Administer Standard: JB8734.5-1998

Diameter: $\Phi 5$ mm

Twist Line Space: 50 mm

Multi Core Line: 0.4 mm²/radix

Wire Guage: AWG 20#

Core Line Color: Red and Black

Shield Floor: 128 Intwine



Warning

Wire with power off. The flow meter must be reliable grounding before installation.

1.3 Powering on

As soon as the Flowmeter is switched on, the self-diagnosis program will start to run. If any error is detected, an error code will display on the screen (Refer - Error Diagnoses). After that self-diagnosis, the system will run automatically according to the last input parameters.





If the installation is accomplished when system is switched on, gain adjustment can be monitored in Window M01. Generally, after the upper right corner of the display shows two steps of *I and *G, the system will activate the normal measurement condition automatically. And the upper right corner will show "*R". If the signal is not ideal, the above process may cycle several times.

If it is the first time to use or install on a new site, the customer need to input the new installation site parameters. The system will default to the last window settings and automatically display them at next power on.







1.4 Keypad Functions

This keypad is dual function keypad:

1. When separately pressed, is shortcut function, referring to "2. Quickly set menu instructions ";
2. Press  and Number key, is Menu key, referring to "6.Menu Window Description".

 Select a menu. Press this key first, input two menu numbers and then enter the selected menu. For example, to input a pipe outside diameter, press    keys, where "11" is the window ID to display the parameter for pipe outside diameter.



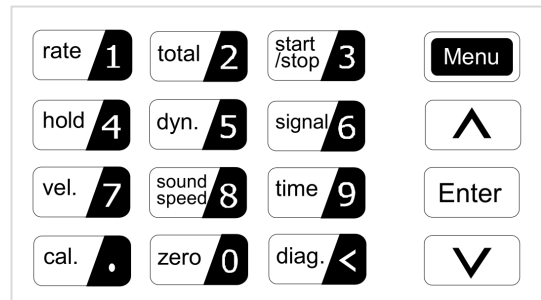

Follow these guidelines when using the Flowmeter keypad (Refer to Keypad Figure):







-  ~  And  To input numbers.
-  Backspace or delete characters to the left.
-  And  Return to the last menu or to open the next menu. Acts as "+" and "-" functions when entering numbers.





1.5 Keypad Operation

The flow meter adopts the window software design to consolidate or subdivide all of the parameters entered, the instrument setup and measurement result displays into more than 100 independent windows. The operator can input parameters, modify settings or display measurement results by "visiting" a specific window. These windows are arranged by 2-digit serial numbers (including "+" sign) from 00~99, then to +0, +1, etc. Each window serial number, or so-called window ID code, has a defined meaning. For example, Window M11 indicates the parameter input for pipe outside diameter, while Window M25 indicates the mounting spacing between the transducers, etc. (Refer - Windows Display Explanations).

The keypad shortcut to visit a specific window is to press the  key at any time, then input the 2-digit window ID code. For example, to input or check the pipe outside diameter, just press the    keys for window ID code 11.

Another method to visit a particular window is to press  and  keys to scroll the screen. For example, if the current window ID code is M02, press  key to enter Window M01, press the  button again to enter Window M00; then, press the  key to back Window M01, and press the  key again to enter Window M02.

Windows are separated into three types: (1) Data Type, such as M11, M12; (2) Option Type, such as M14; (3) Pure Display Type, such as M01, M00.

You can check the corresponding parameters by visiting the Data Type Windows. If you want to modify the parameters, input the digits and press  or press  first, input the digits then press  again to confirm.

Example1: To enter a pipe outside diameter of 219.234, the procedure is as follows:

Press **Menu** **1** **1** keys to enter Window M11 (the numerical value displayed currently is a previous value). Now press **Enter** key. The symbol ">" and the flashing cursor are displayed at the left end of the second line on the Screen. Then input the parameters; or do not press the **Enter** key, directly enter **2** **1** **9** **.** **2** **3** **4** **5** **Enter**.



You can check the selected option by visiting Option Type Windows. If you want to modify it, you must press **Enter** first, the symbol ">" and the flashing cursor are displayed at the left of the Screen. Operator can use the **^** and **v** to scroll the screen and get the required value then press **Enter** to confirm; or enter the corresponding value option directly and press **Enter** to confirm.



For example, if the pipe material is "Stainless Steel", Press **Menu** **1** **4** to enter Window M14, press **Enter** to modify the options. Select the "1. Stainless Steel" option by pressing **^** and **v**, then press **Enter** to confirm the selection; It is possible to press **1** key to change the selection and wait until "1.Stainless Steel" is displayed on the second line of the screen, then press **Enter** to confirm.

Attention



Generally, press **Enter** key first if operator wants to enter "modify" status. If the "modify" is still not possible even after pressing the **Enter** key, it means that system is locked by a password. To "Unlock" it, select "Unlock" in Window M47 and enter the original password.

1.6 Flowmeter Window Descriptions

These windows are assigned as follows:

- 01~08 Flow Totalizer Display: to display flow rate, positive total, negative total, net total, velocity, date & time, present operation and flow results today, etc.
- 10~29 Initial Parameter Setup: to enter pipe outside diameter, pipe wall thickness, fluid type, transducer type, transducer mounting method and spacing, etc.
- 30~38 Flow Units Options: to select the flow unit such as cubic meter, liter or other units, can turn totalizers on/off and reset totalizers, etc.
- 40~49 Setup options: Scaling factor, system lock (Window M47), etc.
- 55~89 Input and output setup: date and time, ESN, communication baud rate setting, etc.
- 90~98 Diagnoses: Signal strength and signal quality (Window M90), TOM/TOS*100 (Window M91), flow sound velocity (Window M92), total time and delta time (Window M93), Reynolds number and factor (Window M94), etc.
- +0~+5 Appendix: power on/off time, total working hours, on/off times and a single-accuracy function calculator.

Attention



The other windows for hardware adjustment are reserved by the manufacturer.

2 Pipe Parameter Entry Shortcuts

2.1 Dual function keys menu description

Press  key

Display Net Flow Today /Flow Max /Flow Min/The Average/Current Rate in turn.



```
Flow Max.
  350.000 m3/h
```

Press  key

Display Day Totalizer Flow /Monthly Totalizer Flow / Yearly Totalizer Flow in turn.



```
Day Totalizer
  700.1000 m3
```

Press  key

Display Totalizer Start and Stop in turn.



```
      1060      sec
ON      15.858 m3
```

按下  键

Flow rate and net flow totalizer are displayed in the sequence (keep display).



```
Flow  0.1129 m3/h *R
POS   0.01 m3
```

按下  键

Displays instantaneous flow and instantaneous flow velocity dynamic modes (damping 1 or 10)



```
Flow 100.000 m3/h Dyn
Vel   1.0415 m/s
```

Press  key

Display Signal Strength and Signal Quality.



```
Strength+Quality [90
UP: 0.0 DN: 0.0 0=00
```

Press  key

Display Flow Rate and Velocity.



```
Flow  20.112 m3/h *R
Vel   1.0415 m/s
```

Press  key

Display Flow Sound Velocity.



```
Fluid Sound Velocity
  1500.0 m/s
```

按下  键

Display date, time and flow rate.

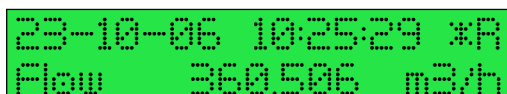

```
23-10-06 10:25:29 *R
Flow  360.506 m3/h
```

Press  key

Press Ent to start Manual Totalizer, then press Ent to end Manual Totalizer, press Ent to input Standard Totalizer to get the final K factor. Complete the calibration with pressing Ent to store.



Manual Calibrate
Press ENT When Ready

Press  key

Input Code 1234 to complete Reset Zero.



Set Zero
Please Enter PW

Press  key

Display System Error Codes.







*R-----
System Normal

2.2 Examples

For example, measuring the diameter of 219mm and pipe wall thickness of 6mm, measuring medium is water, Pipe Material is carbon steel, No Liner, can be operated as follows:





Step1. Pipe outside diameter:

Press    keys to enter Window M11, and enter the pipe outside diameter, and then press the  key to confirm.



Pipe Outer Diameter
219.00 mm







Step2. Pipe wall thickness

Press the    key to enter Window M12, and enter the pipe wall thickness, and press the  key to confirm.



Pipe Wall Thickness
6 mm

Step3. Pipe Material







Press the    keys to enter Window M14, press the  key, press the  or  key to select Pipe Material, and press the  key to confirm.



Pipe Material [14
0. Carbon Steel

Step4. Transducer type

(The transmitter is available for various transducer types.)

Press the    key to enter Window M23, press the  key, move the  or  key to select transducer type, and press the  key to confirm.

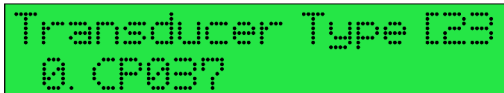

Transducer Type [23
0. CP037

Step5. Transducer mounting methods

Press the **Menu** **2** **4** key to enter Window M24, press the **Enter** key, press the **^** or **v** key to select transducer-mounting method, and press the **Enter** key to confirm.



Transducer Mounting
O. V

Step6. Adjust Transducer spacing

Press the **Menu** **2** **5** key to enter Window M25, accurately install the transducer according to the displayed transducer mounting spacing and the selected mounting method (Refer to Installing the Transducers in this chapter).

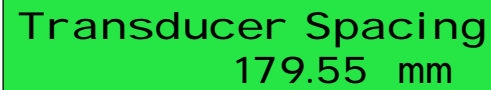

Transducer Spacing
179.55 mm

Step7. Display measurement result

Press the **Menu** **0** **1** keys to enter Window M01 to display measurement result. (Base on the actual measurement)

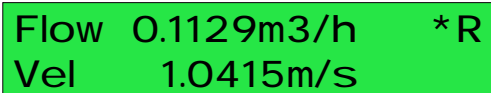

Flow 0.1129m3/h *R
Vel 1.0415m/s

3 Measurement Site Selection

When selecting a measurement site, it is important to select an area where the fluid flow profile is fully developed to guarantee a highly accurate measurement. Use the following guidelines to select a proper installation site:

Choose a section of pipe that is always full of liquid, such as a vertical pipe with flow in the upward direction or a full horizontal pipe.

Ensure enough straight pipe length at least equal to the figure shown below for the upstream and downstream transducers installation.

Name	Straight length of Upstream piping	Straight length of Downstream piping
90° bend		
Tee		
Diffuser		
Reducer		
Value		
Pump		

Ensure that the pipe surface temperature at the measuring point is within the transducer temperature limits.

Consider the inside condition of the pipe carefully. If possible, select a section of pipe where the inside is free of excessive corrosion or scaling.

4 Transducer Installation

4.1 Installing the transducers

Before installing the transducers, clean the pipe surface where the transducers are to be mounted. Remove any rust, scale or loose paint and make a smooth surface. Choose a section of sound conducting pipe for installing the transducers. Apply a wide band of sonic coupling compound down the center of the face of each transducer as well as on the pipe surface, ensure there are no air bubbles between the transducers and the pipe wall, and then attach the transducers to the pipe with the straps provided and tighten them securely.

Note:

The two transducers should be mounted at the pipe’s centerline on horizontal pipes.

Make sure that the transducer mounting direction is parallel with the flow.

During the installation, there should be no air bubbles or particles between the transducer and the pipe wall. On horizontal pipes, the transducers should be mounted in the 3 o’clock and 9 o’clock positions of the pipe section in order to avoid any air bubbles inside the top portion of the pipe. (Refer to Transducer Mounting). If the transducers cannot be mounted horizontally symmetrically due to limitation of the local installation conditions, it may be necessary to mount the transducers at a location where there is a guaranteed full pipe condition (the pipe is always full of liquid).

4.1.1 Transducer Spacing

After entering the required parameters, the spacing between the ENDS of the two transducers is considered as the standard transducer spacing (Refer to Top View on transducer mounting methods). Check the data displayed in Window M25 and space the transducers accordingly.

4.1.2 Transducer Mounting Methods

Three transducer mounting methods are available. They are respectively: V method, Z method and N method. The V method is primarily used on small diameter pipes (DN100~300mm, 4” ~12”). The Z method is used in applications where the V method cannot work due to poor signal or no signal detected. In addition, the Z method generally works better on larger diameter pipes (over DN300mm, 12”) or cast iron pipes.

The N method is an uncommonly used method. It is used on smaller diameter pipes (below DN50mm, 2”).

4.1.3 V Method

The V method is considered as the standard method. It usually gives a more accurate reading and is used on pipe diameters ranging from 25mm to 400mm (1 ” ~16”) approximately. Also, it is convenient to use, but still requires proper installation of the transducers, contact on the pipe at the pipe’s centerline and equal spacing on either side of the centerline.

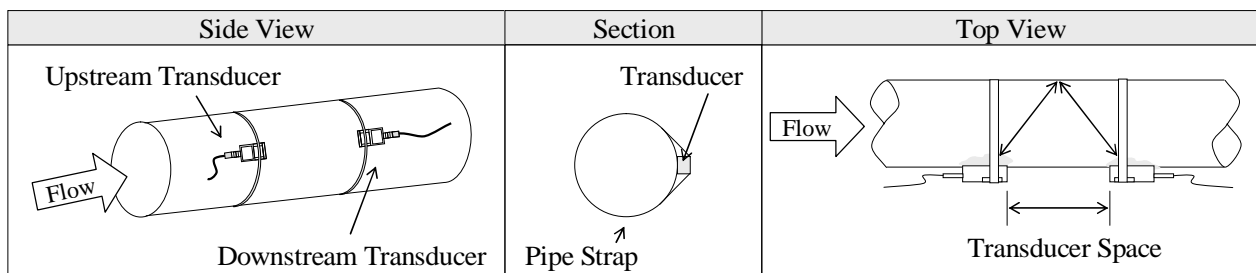

4.1.4 Z Method

The signal transmitted in a Z method installation has less attenuation than a signal transmitted with the V method when the pipes are too large, there are some suspended solid in the fluid, or the scaling and liner are too thick. This is because the Z method utilizes a directly transmitted (rather than reflected) signal which transverses the liquid only once.

The Z method is able to measure on pipe diameters ranging from 100mm to 800mm (4" ~32") approximately. Therefore, we recommend the Z method for pipe diameters over 300mm (12").

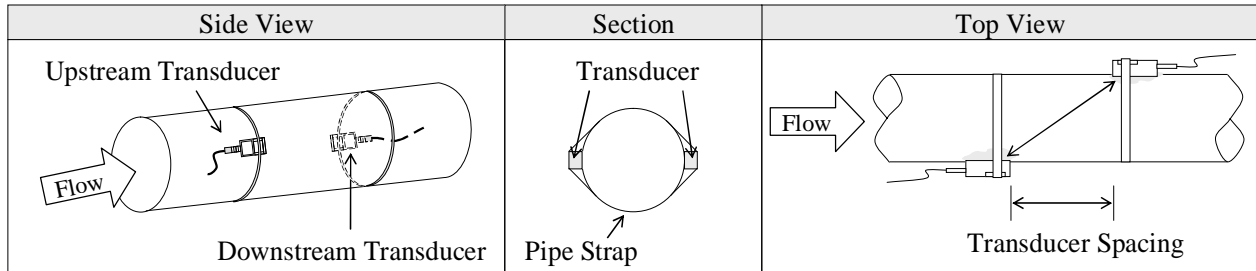

4.1.5 N Method (not commonly used)

With the N method, the sound waves traverse the fluid three times and bounce twice off the pipe walls. It is suitable for small pipe diameter measurement.

The measurement accuracy can be improved by extending the transit distance with the N method (uncommonly used).

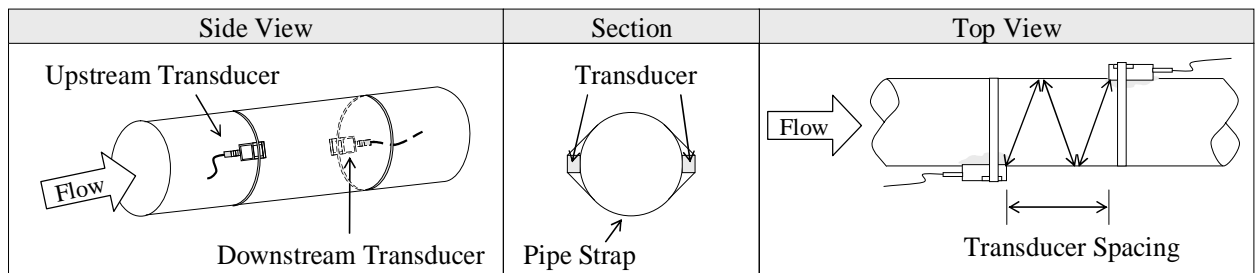

4.2 Transducer Mounting Inspection

Check to see if the transducer is installed properly and if there is an accurate and strong enough ultrasonic signal to ensure proper operation and high reliability of the transducer. It can be confirmed by checking the detected signal strength, total transit time, delta time as well as transit time ratio.

The "mounting" condition directly influences the flow value accuracy and system long-time running reliability. In most instances, only apply a wide band of sonic coupling compound lengthwise on the face of the transducer and stick it to the outside pipe wall to get good measurement results. However, the following inspections still need to be carried out in order to ensure the high reliability of the measurement and long-term operation of the instrument.

4.2.1 Signal Strength

Signal strength (displayed in Window M90) indicates a detected strength of the signal both from upstream and downstream directions. The relevant signal strength is indicated by numbers from 00.0~99.9. 00.0 represents no signal detected while 99.9 represents maximum signal strength.

Normally, the stronger the signal strength detected, the longer the operation of the instrument reliably, as well as the more stable the measurement value obtained.

Adjust the transducer to the best position and check to ensure that enough sonic coupling compound is applied adequately during installation in order to obtain the maximum signal strength.

System normally requires signal strength over 60.0, which is detected from both upstream and downstream directions. If the signal strength detected is too low, the transducer installation position and the transducer mounting spacing should be re-adjusted and the pipe should be re-inspected. If necessary, change the mounting method to be Z method.

4.2.2 Signal Quality (Q value)

Q value is short for Signal Quality (displayed in Window M90). It indicates the level of the signal detected. Q value is indicated by numbers from 00~99. 00 represents the minimum signal detected while 99 represent the maximum.

Normally, the transducer position should be adjusted repeatedly and coupling compound application should be checked frequently until the signal quality detected is as strong as possible.

4.2.3 Total Time and Delta Time

"Total Time and Delta Time", which displays in Window M93, indicates the condition of the installation. The measurement calculations in the Flowmeter are based upon these two parameters. Therefore, when "Delta Time" fluctuates widely, the flow and velocities fluctuate accordingly, this means that the signal quality detected is too poor. It may be the resulted of poor pipe-installation conditions, inadequate transducer installation or incorrect parameter input.

Generally, "Delta Time" fluctuation should be less than $\pm 20\%$. Only when the pipe diameter is too small or velocity is too low can the fluctuation be wider.

4.2.4 Transit Time Ratio

Transit Time Ratio indicates if the transducer mounting spacing is accurate. The normal transit time ratio should be 100 ± 3 if the installation is proper. Check it in Window M91.

Attention

If the transit time ratio is over 100 ± 3 , it is necessary to check:



- (1) If the parameters (pipe outside diameter, wall thickness, pipe material, liner, etc.) have been entered correctly,
- (2) If the transducer mounting spacing is accordance with the display in Window M25,
- (3) If the transducer is mounted at the pipe's centerline on the same diameter,

If the scale is too thick or the pipe mounting is distorted in shape, etc.

4.2.5 Warnings

- (1) Pipe parameters entered must be accurate; otherwise the Flowmeter will not work properly.
- (2) During the installation, apply enough coupling compounds in order to stick the transducers onto the pipe wall. While checking the signal strength and Q value, move the transducers slowly around the mounting site until the strongest signal and maximum Q value can be obtained. Make sure that the larger the pipe diameter, the more the transducers should be moved.
- (3) Check to be sure the mounting spacing is accordance with the display in Window M25 and the transducer is mounted at the pipe's centerline on the same diameter.
- (4) Pay special attention to those pipes that formed by steel rolls (pipe with seams), since such pipe is always irregular. If the signal strength is always displayed as 0.00, that means there is no signal detected. Thus, it is necessary to check that the parameters (including all the pipe parameters) have been entered accurately. Check to be sure the transducer mounting method has been selected properly, the pipe is not worn-out, and the liner is not too thick. Make sure there is indeed fluid in the pipe or the transducer is not too close to a valve or elbow, and there are not too many air bubbles in the fluid, etc. With the exception of these reasons, if there is still no signal detected, the measurement site has to be changed.

- (5) Make sure that the Flowmeter is able to run properly with high reliability. The stronger the signal strength displayed, the higher the Q value reached. The longer the Flowmeter runs accurately, the higher the reliability of the flow rates displayed. If there is interference from ambient electromagnetic waves or the signal detected is too poor, the flow value displayed is not reliable; consequently, the capability for reliable operation is reduced.
- (6) After the installation is complete, power on the instrument and check the result accordingly.

5 Operating Instructions

5.1 System Normal Identification

Press the keys. If the letter "*R" displays on the screen, it indicates system normal.

If the letter "G" is displayed, it indicates that system is adjusting the signal gain prior to the measurement. Also, it means system normal. Only when the adjustment takes too long without stopping, can system be identified as abnormal.

Letter "I" indicates no signal is being detected. Check the transducer wiring connections are correct, the transducers are installed firmly, etc.

5.2 Zero Set Calibration

Once zero flow occurs, a zero point may indicate on each measuring instrument, but the displayed measuring value is not equal to "0", this value indicates "Zero". To any measuring instrument, the smaller the "Zero" is, the better the quality is. Conversely, if the Zero is too big, that indicates the quality of the instrument is poor.

If the zero set point is not at true zero flow, a measurement difference may occur. The smaller the physical measurement capacity is, the larger the measurement difference from the zero point will exist. Only when zero point reduced to a definite degree, as compared with the physical measurement capacity, can the measuring difference from zero point be ignored.

For an ultrasonic Flowmeter, the measurement difference from zero point cannot be ignored at low flow. It is necessary to perform a static zero set calibration to improve low flow measurement accuracy.

Press Window M42 to set the Zero, press first, and then wait the readings displayed at the lower right corner reducing to be "0". If this is carried out with flow, the flow will be displayed as "0", M43 can help to restore settings.

5.3 Scale Factor

Scale factor refers to the ratio between "actual value" and "reading value". For example, when the measurement and is 2.00, and it is indicated as 1.98 on the instrument, the scale factor reading is 2/1.98. This means that the best scale factor constant is 1.

However, it is difficult to keep the scale factor as "1" on the instrument especially in batch productions. The difference is called "consistency".

During operation, there still exists possible difference in pipe parameters, etc. The "scale factor" may be necessary when used on different pipes. Thus, scale factor calibration is specially designed for calibrating the differences that result from application on different pipes. The scale factor entered must be one that results from actual calibration. The scale factor can be input in Window M45.

5.4 System Lock

System lock is readable but not modifiable to prevent operation error due to unauthorized tampering by unauthorized personnel.

Press the keys, if displays "Unlock" on the screen, then press the key, enter 6 numerically long password, and then press the key to confirm.

Unlock it by using the selected password only. Press , if "lock" is displayed on the screen, then press the key and enter the correct password, then press to confirm.

Keep the password in mind or recorded in a safe place, otherwise the instrument cannot be used.

5.5 Frequency Output

The Flowmeter is provided with a frequency output transmitter function. The high or low frequency output displayed indicates the high or low flow rate reading. The user can reset the frequency output as well as flow rate as his requirements.

For example: if a pipe flow range is 0~3000m³/h, the relative frequency output required is 0~5000Hz, and the configuration is as follows:

In Window M68 (low limit frequency output flow value), input 0;

In Window M69 (high limit frequency output flow value), input 3000;

Typical OCT Output wiring diagram as below:

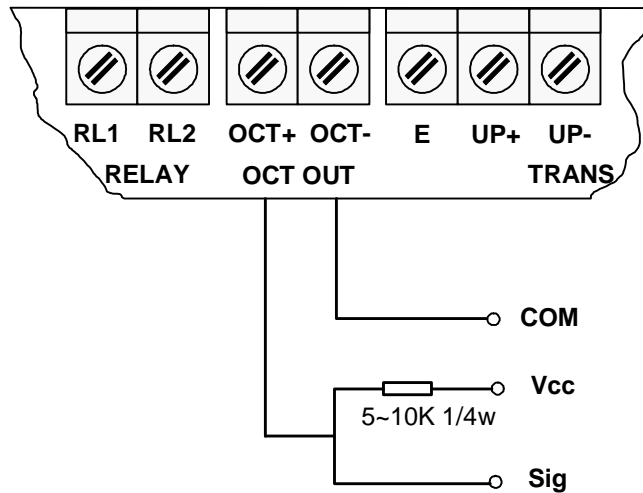

OCT Output Wiring Diagram

5.6 4~20mA Current Loop Output Verification (Optional)

Processing a current loop output exceeding an accuracy of 0.1%, the flowmeter is programmable and configurable with multiple output modes such as flow rate or fluid velocity. Select in Window M55. For details, please refer to "Windows Display Explanations".

In Window M56, enter a 4mA flow rate or fluid velocity value. Enter the 20mA flow rate or fluid velocity value in Window M57. For example, if the flow range in a specific pipe is 0~1000m³/h, enter 0 in Window M56 and 1000 in Window M57.

Calibrating and testing the current loop is performed in Window M58. Complete the steps as follows:

Press **Menu** **5** **8** **Enter**, move **^** or **v** to display "0mA", "4mA", "8mA", "12mA", "16mA", "20mA" readings, connect an ammeter to test the current loop output and calculate the difference. Calibrate it if the difference is within tolerance. If the difference is without tolerance, refer to the "Analog Output Calibration" to calibrate the current loop.

Check the present current loop output in Window M59 as it changes along with change in flow.

5.7 Recover the Factory Default

Press **Menu** **3** **7** **Enter** keys to Window m37, press **^** or **v** key to choose "Reset" keys to recover the factory default.

5.8 4~20mA Analog Output Calibration

**Note**

Each flowmeter has been calibrated strictly before leaving factory. It is unnecessary to carry through this step except when the current value (detected while calibrating the current loop) displayed in Window M58 is not identical with the actual output current value.

The hardware detect window must be activated prior to calibration the Analog Output. The procedure is as follows:

Press enter password "115800", then press to activate the detect menu. With no effect to next power on, this window will close automatically as soon as the power is turned off.

Press to calibrate the current loop 4mA output. Use an ammeter to measure the current loop output current. At the same time, press or to adjust the displayed numbers. Watch the ammeter until it reads 4.00. Stop at this point, the 4mA has been calibrated.

Then, press to calibrate the current loop 20mA output. The method is the same as 4mA calibration.

The results are automatically saved in EEPROM and won't lose when power off.

5.9 ESN

We provide the Flowmeter with a unique electronic serial number to identify each Flowmeter for the convenience of the manufacturer and customers. The ESN is able to be viewed in Window M61.

**Attention**

Other Operation refers to "6.2 Windows Display Explanations".

6 Windows Display Explanations

6.1 Windows Display Codes

Flow Totalizer Display		38	Manual Totalizer	72	Working Timer
01	Flow Rate/Velocity	Setup Options		77	Beeper Setup
02	Flow Rate/POS Totalizer	40	Damping	78	OCT Output Setup
04	Date Time/Flow Rate	41	Low Flow Cutoff Value	79	Relay Output Setup
08	System Error Codes	42	Set Static Zero	82	Date Totalizer
09	POS Flow Today	43	Reset Zero	83	Automatic Correction
Initial Parameter setup		44	Manual Zero Point	Diagnoses	
11	Pipe Outer Diameter	45	Scale Factor	90	Signal Strength and Quality
12	Pipe Wall Thickness	46	Network identifying address code	91	TOM/TOS*100
14	Pipe Material	47	System Lock	92	Fluid Sound Velocity
23	Transducer Type	Input and output setup		93	Total Time and Delta
24	Transducer Mounting Method	55	CL Mode Select	94	Reynolds Number and Factor
25	Transducer Spacing	56	CL 4mA Output Value	97	Transducer Spacing correction selection
26	Parameters Setups	57	CL 20mA Output Value	Appendix	
27	Cross-sectional Area	58	CL Check	+0	Last Power Off Time and Flow Rate
28	Holding with Poor Sig	59	CL Current Output	+1	Total Working Hours
29	Empty Pipe Setup	60	Date and Time	+2	Last Power Off Time
Flow Units Options		61	ESN	+3	Last Flow Rate
30	Metric system Units	62	Serial Port Parameter	+4	Total Power Off Times
31	Flow Rate Units	67	FO Frequency Range	-0	Hardware Adjusting Entry
32	Totalizer Units	68	Low FO Flow Rate		
33	Totalizer Multiplier	69	High FO Flow Rate		
35	POS Totalizer	70	LCD Backlit Option		
37	Totalizer Reset				

NOTE: The other menu features are retained by manufacturers and the windows in gray background are optional functions.

6.2 Display Explanation

Menu 0 1

Display Flow Rate and Velocity.

Flow 0.1129m³/h *R
Vel 1.0415m/s

Menu 0 2

Flow Rate / POS Totalizer

Display Flow Rate and POS Totalizer.

Select the POS Totalizer units in Window M31.

If the POS Totalizer has been turned off, the POS

Totalizer value displayed is the total prior to its turn off.

Flow 0.1129m³/h *R
POS 0x1m³

Menu 0 4

Date Time / Flow Rate

The time setting method can be found in Window M60.

03-04-03 15:49:40 *R
Flow 0.1116 m³/h

Menu 0 8

System Error Codes

Display the Working Condition and the System Error Codes. More than one error code can occur at the same time.

The explanations of error codes and detailed resolution methods can be found in "Error Diagnoses"

*R -----
System Normal

Menu 0 9

POS Flow Today

Display POS Flow Today.

POS Flow Today [09
0.000 m³

Menu 1 1

Pipe Outer Diameter

Enter the pipe outside diameter or enter the pipe circumference in Window M10. The pipe outside diameter must range from 10mm to 6000mm.

Note: Enter either pipe outside diameter or pipe circumference.

Pipe Outer Diameter
60.00 mm

Menu 1 2

Pipe wall thickness**Pipe Wall Thickness**
2.00 mm

Menu 1 4

Pipe Material

Enter pipe material. The following options are available (by 、 buttons or numerical keys):

0. Carbon Steel
1. Stainless Steel
2. PVC
3. Copper

Pipe Material [14]
0. Carbon Steel

Menu 2 3

Transducer Type

0. CP037(CP series clamp-on type transducer)
1. CP035(CP series clamp-on type transducer)
2. Plug-in-W211(W211 type insertion transducer)

Transducer Type [23]
0. CP037

Menu 2 4

Transducer Mounting

Four mounting methods are available:

0. Z
1. V
2. N (small pipe)

Transducer Mounting
1. V

Menu 2 5

Transducer Spacing

The operator must mount the transducer according to the transducer spacing displayed (be sure that the transducer spacing must be measured precisely during installation). The system will display the data automatically after the pipe parameter had been entered.

Transducer Spacing
159.86 mm

Menu 2 6

Initial Parameter Setups and Save

Load and save the parameters. 18 different sets of setup conditions/groups are available to load and save by three methods

0. Entry to Save
1. Entry to Load
2. To Browse

Select "Entry to Save", press . An ID code and the original parameters are displayed in the window. Press UP or DOWN ARROW to move the ID code, then press the key again to save the current parameter in the current ID room. When selecting "Entry to Load", press ENT, and the system will read and calculate the parameters automatically and display the transducer mounting spacing in Window M25.

Menu 2 7

Cross-sectional Area

Menu 2 8

Holding with Poor Sig

Select "Yes" to hold last good flow signal displayed if the Flowmeter experiences a poor signal condition. This function will allow to calculate flow totalizer data without interruption. Select "NO", instead.

Menu 2 9

Empty Pipe Setup

This parameter is used to overcome the possible problems that usually show up when the pipe being measured is empty. Since signals can be transmitted through the pipe wall, the flow meter may still read a flow while measuring an empty pipe. To prevent this condition from happening, you can specify a value. When the signal quality falls below this value, the measurement stops automatically. If the flow meter is already able to stop measuring when the pipe is empty, a value in the range of 30 to 40 should also be entered in this window to ensure no measurement when the pipe is empty.

Parameter Setups
Entry to SAVE

Cross-sectional Area
31415.9 mm²

Holding with Poor Sig
NO

Empty Pipe Setup [29
30

Menu 3 0

Measurement Units Options

Select the measurement unit as follows:

- 0. Metric
- 1. English

Measurement Units In
0. Metric

Menu 3 1

Flow Rate Units Options

The following flow rate units are available:

- 0. m3 Cubic Meters
- 1. 1 Liters
- 2. gal USA Gallons
- 3. ig Imperial Gallons
- 4. mg Million Gallons
- 5. cf Cubic Feet
- 6. bal USA Barrels
- 7. ib Imperial Barrels
- 8. ob Oil Barrels

Flow Rate Units [31
m3/h

The following time units are available:

- / Day / Hour
- / Min / Sec

Factory default is Cubic Meters/hour

Menu 3 2

Totalizer Units Options

Select totalizer units. The available unit options are as same as those found in Window M31. The user can select units as their requirement. Factory default is Cubic Meters.

Totalizer Units [32
Cubic Meter (m3)

Menu 3 3

Totalizer Multiplier Options

The totalizer multiplier acts as the function to increase the totalizer indicating range. Meanwhile, the totalizer multiplier can be applied to the positive totalizer, negative totalizer and net totalizer. The following options are available:

- 0. x 0.001 (1E-3)
- 1. x 0.01
- 2. x 0.1
- 3. x 1
- 4. x 10
- 5. x 100

- 6. x 1000
- 7. x 10000(1E+4)
- 8. None

Factory default factor is 8. None

Totalizer Multiplier
0. x0.001(1E-3)

Menu 3 5

ON/OFF POS Totalizer

On/off POS Totalizer. "NO" indicates the Flowmeter starts to totalize the value. When it is turned off, the positive totalizer displays in Window M02 will not change. Factory default is "YES".



Menu 3 7

Totalizer Reset

Totalizer reset; all parameters are reset. Press ; press or arrow to select "YES" or "NO". After "YES" is selected, the following options are available:



- None:No reset;
- All:Reset all totalizers;
- NET Totalizer Reset;
- POS Totalizer Reset;
- NEG Totalizer Reset;
- Reset:back to the factory default

If the user wants to delete all the already set parameters and set back to the factory default, select reset in this window and then the flow meter will reset to be the factory default automatically.



Attention

This operation will delete the entire user's data and reset as the factory default. Please consider carefully before taking this operation.

Menu 3 8

Manual Totalizer

The manual totalizer is a separate totalizer. Press to start, and press to stop it. It is used for flow measurement and calculation.



Menu 4 0

Damping Factor

The damping factor ranges from 0~999 seconds. 0 indicates no damping; 999 indicates the maximum damping.



The damping function will stabilize the flow display. Its principle is the same as that in a single-section RC filter. The damping factor value corresponds to the circuit time constant. Usually a damping factor of 3 to 10 is recommended in applications.

Menu 4 1

Low Flow Cut off Value

Low Flow Cut off is used to make the system display as "0" value at lower and smaller flows to avoid any invalid totalizing. For example, if the cutoff value is set as 0.03, system will take all the measured flow values below ± 0.03 as "0". Usually 0.03 is recommended in most applications.

Low Flow Cutoff Val
0.030 m/s

Menu 4 2

Set Static State Zero

When fluid is in the static state, the displayed value is called "Zero Point". When "Zero Point" is not at zero in the Flowmeter, the difference is going to be added into the actual flow values and measurement differences will occur in the Flowmeter.

Set zero must be carried out after the transducers are installed and the flow inside the pipe is in the absolute static state (no liquid movement in the pipe). Thus, the "Zero Point" resulting from different pipe mounting locations and parameters can be eliminated. The measuring accuracy at low flow is enhanced by doing this and flow offset is eliminated.

Press , wait for the process to complete.

When the zero point is greater than 0.3m/s, the static zero point function setting will not be possible.

Set Zero [42]
Press ENT to go

Menu 4 3

Reset Zero

Select "YES"; reset "Zero Point" which was set by the user.

Reset Zero [43]
NO

Menu 4 4

Manual Zero Point

This method is not commonly used. It is only suitable for experienced operators to set zero under conditions when it is not preferable to use other methods. Enter the value manually to add to the measured value to obtain the actual value. For example:

Actual measured value = 250 m³/H

Actual measured value = 10 m³/H

Flowmeter Display = 240 m³/H

Normally, set the value as "0".

Manual Zero Point [44]
0.000 m³/h

Menu 4 5

Scale Factor

The scale factor named as instrument K factor is used to modify the measurement results. The user can enter a numerical value according to the actual calibration results.

Scale Factor [45]
1.000

Menu 4 6

Network IDN

Input system identifying code, these numbers can be selected from 1~247 except that 13 (ODH ENTER), 10 (0AH Newline), 42 (2AH *) and 38 (26H&) are reserved.

System IDN is used to identify the flowmeter to a network.

Network IDN [46]
88

Menu 4 7

System Lock

Lock the instrument, Once the system is locked, any modification to the system is prohibited, but the parameter is readable. "Unlock" using your designated password. The password is composed of 6 numbers.

System Lock [47]
***** Unlock *****

Menu 5 5

Current Loop Mode Select

CL Mode Select [55]
0: 4 - 20 mA vs. Flow

- 0. 4-20mA set up the 4-20mA output to. be flow rate mode
- 1. 4-20mA vs.Vel. set up the 4-20mA output to. be velocity mode

Other different current output characteristics are displayed in below figures. The user can select one of them according to his actual requirements.

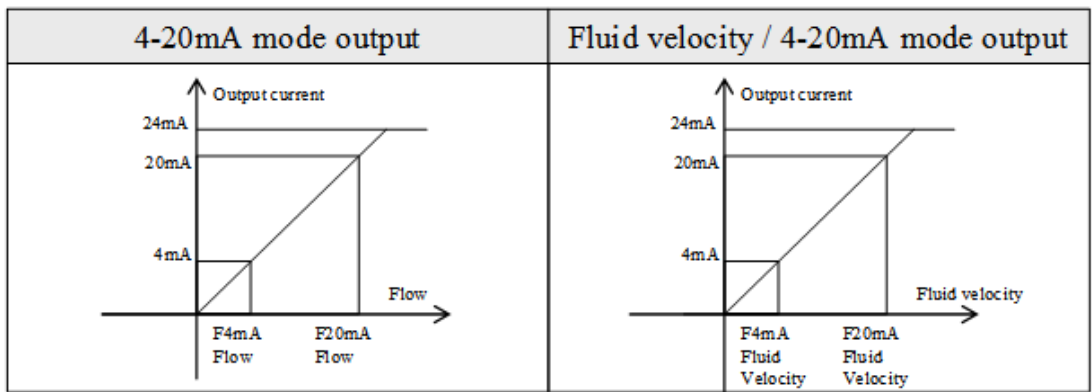

In two graphs shown above, flow F_{4mA} indicates the value that the user entered in Window M57; and flow F_{20mA} indicates the value that the user entered in Window M58. In the 4-20mA modes, F_{4mA} and F_{20mA} can be selected as a positive or negative flow value as long as the two values are not the same.

Menu 5 6

CL 4mA Output Value

Set the CL output value according to the flow value at 4mA. The flow unit's options are the same as those in Window m31.

Once "4-20mA vs.Vel." is selected in Window M56, the unit should be set as m/s.

CL 4mA Output Value
0.000 m3/h

Menu 5 7

CL 20mA Output Value

Set the CL output value according to the flow value at 20mA. the flow unit is the same as that found in Window m31.

Once "4-20mA vs.Vel." is selected in Window M57, the unit should be set as m/s.

CL 20mA Output Value
14400 m3/h

Menu 5 8

CL Check Verification

Check if the current loop has been calibrated before leaving the factory. Press **Enter** to start, press **^** or **v** to display 0mA, 4mA, 8mA, 12mA, 16mA, 20mA, and at the same time, check with an ammeter to measure the current loop output current and calculate the differences to see if it is under the permitted tolerance. If not, refer to the "Analog Output Calibration" to calibrate.

CL Checkup [58]
Press ENT When Ready

Menu 5 9

CL Current Output

Display CL current output. The display of 10.0000mA indicates that CL current output value is 10.0000mA.

If the difference between displaying value and CL output value is too large, the current loop then needs to be re-calibrated accordingly.

CL Current Output [59]
15.661 mA

Menu 6 0

Date and Time Settings

Date and time modifications are made in this window. The format for setting time setting is 24 hours. Press **Enter**, wait until ">" appears, the modification can be made.

YY-MM-DD HHMMSS
23-06-04 100504

Menu 6 1

ESN

Display electronic serial number (ESN) of the instrument. This ESN is the only one assigned to each Flowmeter ready to leave the factory. The factory uses it for files setup and the user uses it for management.

Menu 6 2

Serial Port Settings

This window is used for serial port setting. Serial port is used to communicate with other instruments. The serial port parameters setting of the instrument that applies the serial port connection must be consistency. The first selected data indicates baud rate, 2400, 4800, 9600, 19200, 38400, 56000 are available.

The second option indicates parity bit, None (No verification).

Data length fixed to 8;

Stop bit length for a fixed length.

The factory default serial port parameter is "9600, None".

Menu 6 7

FO Frequency Range

Set the highest limit of the output signal frequency. highest limit frequency values must be greater than the lower frequency range: 0-9999Hz, Factory default: 1~1001Hz.

Note: output frequency signal output from OCT mouth, so to output frequency signal, must also Be set OCT into frequency signal output mode (M78 choose 0. FO).

Menu 6 8

Low FO Flow Rate

Set up low FO flow rate, i.e. the corresponding flow value when output signal frequency is at the lowest FO frequency. For example, when the low FO frequency is 1000 Hz, low FO flow rate is 100m³/h then when the frequency output is 1000 Hz, the low flow at this moment measured by the Flowmeter is 100m³/h.

**Ultrasonic Flowmeter
S/N=v6500158****RS485 Setup [62
9600 None****FO Frequency Range
1 - 5000****Low FO Flow Rate [68
0 m³/h**

Menu 6 9

High FO Flow Rate

Enter the high FO flow rate, i.e. the corresponding flow value when frequency output signal is at highest FO frequency. For example, when the low FO frequency is 5000Hz, low FO flow rate is 1000m³/h, then when the frequency output is 5000Hz, the low flow at this moment measured by the Flowmeter is 1000m³/h.

High Fo Flow Rate [69
2000.000 m³/h

Menu 7 0

LCD Back lit Option

Select LCD back lit controls.

0. Always ON
1. Always OFF
2. Lighting For nn sec

Keep the backlight off can save about 30mA power.

LCD Backlit Option
0. Always ON

Menu 7 2

Working Timer

Display the totalized working hours of the Flowmeter since last reset. It is displayed by HH:MM:SS. If it is necessary to reset it, press , and select "YES".

Working Time [72
210:26:38

Menu 7 7

Beeper Setup

Set up the beeper on-off state.

0. ON Beeper ON
1. OFF Beeper OFF

BEEPER Setup [77
0. ON

Menu 7 8

OCT Output Setup

Set OCT output hardware unit output trigger sources, selection of triggering events:

0. FO
1. NET Int Pulse

OCT Output Setup [78
0. FO

Menu 7 9

Relay Output Setup

The relay is single-pole and constant-on for external instrument controls. The following options are available:

- 0. Not Using
- 1. NET Int Pulse

RELAY Output Setup
0. Not Using

Menu 8 2

Date Totalizer

In this window, it is possible to review the historical flow data totalizer for any day of the last 64 days, any month of the last 64 months and any year of the last 5 years.

Press , use the or to review totalizer in days, months and years. "0" for day, "1" for month, "2" for year.

Use the or to review the totalizer in some day, some month, some year.

Date Totalizer [82
0. Day

04 22-07-02-----
2976.98 m3

Menu 8 3

Automatic Flow Correction

With the function of automatic flow correction, the flow lost in an offline session can be estimated and automatically adjusted. The estimate is based on the average value, which is obtained from flow rate before going offline and flow measured after going online the next time, multiplied times the time period that the meter was offline. Select "ON" to use this function and "OFF" to cancel this function.

Automatic Correction
OFF

Menu 9 0

Signal Strength and Signal Quality

Display the measured signal strength and signal quality Q value upstream and downstream.

Signal strength is indicated from 00.0~99.9. A reading of 00.0 indicates no signal detected, while 99.9 indicates maximum signal strength. Normally the signal strength should be ≥ 60.0 .

Signal quality Q is indicated by 00~99. Therefore, 00 indicates the poorest signal while 99 indicates the best signal. Normally, signal quality Q value should be better than 50.

During the installation, pay attention to the signal strength and signal quality, the higher, the better. The strong signal strength and high quality value can ensure the long-term stability and the high accuracy of the measurement results.

Strength+Quality [90]
UP:86.2 DN:86.2 Q=98

Menu 9 1

TOM/TOS*100

Display the ratio between the actual measured transmit time and the calculated transmit time according to customer's requirement. Normally the ratio should be $100 \pm 3\%$. If the difference is too large, the user should check whether the parameters are entered correctly, especially the sound velocity of the fluid and the installation of the transducers. This data is of no use before the system is ready.

Tom/Tos *100 [91]
100.32%

Menu 9 2

Fluid Sound Velocity

Display the measured fluid sound velocity.

Fluid Sound Velocity
1443.4 m/s

Menu 9 3

Total Time and Delta Time

Display the measured ultrasonic average time (unit: nS) and delta time of the upstream and downstream (unit: nS) time. The velocity calculation in the Flowmeter is based on the two readings. The delta time is the best indication that the instrument is running steadily. Normally the fluctuation in the ratio of the delta time should be lower than 20%. If it is not, it is necessary to check if the transducers are installed properly or if the parameters have been entered correctly.

Totl Time Delta Time
193.00uS -2.09nS

Menu 9 4

Reynolds Number and Factor

Display the Reynolds number that is calculated by the Flowmeter and the factor that is set currently by the Flowmeter. Normally this scaling factor is the average of the line and surface velocity factor inside the pipe.

Reynolds Number [94
0.0000 1.0000

Menu 9 6

Protocol Select

- 0. FUJI
- 1. MODBUS
- 2. CAL

Protocol Select [96
1. MODBUS

Menu 9 7

Installation spacing correction selection

selection includes the followings:

- OFF Turn off Installation spacing correction
- ON Turn on Installation spacing correction

Spacing Correction
OFF

Menu ^ 0

Power ON/OFF Time

To view the power on/off time and flow rate for the last 64 update times to obtain the offline time period and the corresponding flow rate.

Enter the window, press **Enter** and **^** to display the last update before the last 64 times of on/off time and flow rate values. "ON" on right hand indicates that time power is on; "00" on the upper left corner indicates "22-08-06 16:53:06" the date time; flow rate is displayed in the lower right corner.

ON/OFF Time [+0
Press ENT When Ready

16 22-08-06 16:53:06
*ON 123.65 m3/h

Menu ^ 1

Total Working Hours

With this function, it is possible to view the total working hours since the Flowmeter left the factory. The figure on the right indicates that the total working hours since the Flowmeter left the factory is 28 hours 51 minute 36 seconds.

Total Work Hours [+1
1107:01:41

Menu ^ 2

Display the last power off time.

Last Power Off Time
22-08-26 11:33:02

Menu [^] [3]

Displays the last flow rate.

Last Flow Rate [+3]
100.43 m3/h

Menu [^] [4]

Total ON/OFF Times

Display total on/off times since the Flowmeter left the factory.

ON/OFF Times [+4]
40

Menu [v] [0]

Hardware Parameter Adjusting Entry

Please refer to the 5.8 "4~20mA Analog Output Verification"

Adjust 4-20mA [-0]
Press ENT When Ready

7 Error Diagnoses

The ultrasonic Flowmeter has advanced self-diagnostics functions and displays any errors in the upper right corner of the LCD via definite codes in a date/time order. Hardware error diagnostics are usually performed upon each power on. Some errors can be detected during normal operation. Undetectable errors caused by incorrect settings and unsuitable measurement conditions can be displayed accordingly. This function helps to detect the errors and determine causes quickly; thus, problems can be solved in a timely manner according to the solutions listed in the following tables.

Table 1 applies when errors caused by incorrect settings and signals are detected and are announced by error codes displayed in Window M08.

7.1 Table1. Error codes and solutions

Code	M08 Display	Cause	Solutions
*R	System Normal	* System normal	
*I	Signal Not Detected	<ul style="list-style-type: none"> * Signal not detected. * Spacing is not correct between the transducers or not enough coupling compound applied to face of transducers. * Transducers installed improperly * Scale is too thick. * New pipe liner. 	<ul style="list-style-type: none"> * Attach transducer to the pipe and tighten it securely. Apply a plenty of coupling compound on transducer and pipe wall. * Remove any rust, scale, or loose paint from the pipe surface. Clean it with a file. * Check the initial parameter settings. * Remove the scale or change the scaled pipe section. Normally, it is possible to change a measurement location. The instrument may run properly at a new site with less scale. * Wait until liners solidified and saturated.
*G	Adjusting Gain (Display in Windows M01)	The machine is adjusting for gain,preparing for normal calibration.	

7.2 Frequently Asked Questions and Answers

Question: New pipe, high quality material, and all installation requirements met: why still no signal detected?

Answer: Check pipe parameter settings, installation method and wiring connections. Confirm if the coupling compound is applied adequately, the pipe is full of liquid, transducer spacing agrees with the screen readings and the transducers are installed in the right direction.

Question: Old pipe with heavy scale inside, no signal or poor signal detected: how can it be resolved?

Answer: Check if the pipe is full of fluid.

Try the Z method for transducer installation (If the pipe is too close to a wall, or it is necessary to install the transducers on a vertical or inclined pipe with flow upwards instead of on a horizontal pipe).

Carefully select a good pipe section and fully clean it, apply a wide band of coupling compound on each transducer face (bottom) and install the transducer properly.

Slowly and slightly move each transducer with respect to each other around the installation point until the maximum signal is detected. Be careful that the new installation location is free of scale inside the pipe and that the pipe is concentric (not distorted) so that the sound waves do not bounce outside of the proposed area.

For pipe with thick scale inside or outside, try to clean the scale off, if it is accessible from the inside. (Note: Sometimes this method might not work and sound wave transmission is not possible because of the a layer of scale between the transducers and pipe inside wall).

Question: Why is the flow rate still displayed as zero while there is fluid obviously inside the pipe and a symbol of "R" displayed on the screen?

Answer: Check to see if "Set Zero" was carried out with fluid flowing inside the pipe(Refer to Window M42). If it is confirmed, recover the factory default in Window M43.

8 Product Overview

8.1 Introduction

The ultrasonic flowmeter is a state-of-the-art universal transit-time Flowmeter designed using FPGA chip and low voltage broadband pulse transmission.,available for measuring water.

8.2 Features of D116

Comparing With other traditional flowmeter or ultrasonic flowmeter,it has distinctive features such as high precision, high reliability, high capability and low cost, the Flowmeter features other advantages:

1. SLSI technology designed. Less hardware components, low voltage broadband pulse transmission, low consumption power, high reliability, anti-jamming and outstanding applicability.
2. User-friendly menu designed. Parameters of pipe range, pipe material, pipe wall thickness, output signals, etc can be conveniently entered via the windows. British and Metric measurement units are available.
3. Daily, monthly and yearly totalized flow: Totalized flow for the last 64 days and months as well as for the last 5 years are may be viewed. Power on/off function: allows the viewing of time and flow rate as power is switched on and off 64 times. Also, the Flowmeter has manual or automatic amendment during offline sessions.
4. Parallel operation of positive, negative and net flow totalizes with scale factor (span) and 7 digit display, while the output of totalize pulse and frequency output are transmitted via open collector.

8.3 Specifications

Performance specifications	
Flow range	0.03 ~ 16 ft/s (0.01 ~ 5.0 m/s).
Accuracy	± 1.0 % of measured value , velocity > 0.5m/s.
Pipe size	Clamp-on: 1" ~ 48" (25mm ~ 1200mm).
Fluid	Water.
Pipe material	Carbon steel, stainless steel, PVC, Copper.
Function specifications	
Outputs	OCT Pulse output: 0-9999Hz. Analog output : 4 ~ 20mA, max load 750Ω. Relay output: max. frequency 1Hz (1A@125VAC or 2A@30VDC)
Communication interface	RS485 MODBUS.
Power supply	10 ~ 36VDC/1A.
Keypad	16 (4×4) key with tactile action.
Display	20×2 lattice alphanumeric, back lit LCD.
Temperature	Transmitter: 14 °F to 122 °F (-10°C ~ 50°C); Transducer: 32 °F to 176 °F (0°C ~ 80°C).
Humidity	Up to 99% RH, non-condensing.
Physical specifications	
Transmitter	PC/ABS, IP65.
Transducer	Encapsulated design, IP68.
transducer cable	Standard cable length: 30 ft (9m).
Weight	Transmitter: approximately 0.6kg; Transducer: approximately 0.8kg.

9 Appendix 1-Serial Interface Network Use and Communications Protocol

9.1 Overview

The transmitter has perfect communication protocol. It can also be connected to a RS-485.

Two basic schemes can be chosen for networking, i.e. the analog current output method only using the flowmeter or the RS485 communication method via serial port directly using the flowmeter. The former is suitable to replace dated instruments in old monitoring networks. The later is used in new monitoring network systems. It has advantages such as low hardware investment and reliable system operation.

When the serial port communication method is directly used to implement a monitoring network system, the address identification code (in window M46) of the flowmeter is used as network address code. Expanded command set with [W] is used as communication protocol. Thus analog current loop and OCT output of flowmeter can be used to control the opening of a control valve. The relay output can be used to power-on/off other equipment. The analog input of the system can be used to input signals such as pressure and temperature. The system provides an RTU function for flow measurement.

RS-485(0~1000m) can be directly used for data transmission link for a short distance.

The command answer mode is used in data transmission, i.e. the host device issues commands and the flowmeter answers correspondingly.

9.2 Direct connection via RS-485 to the host device

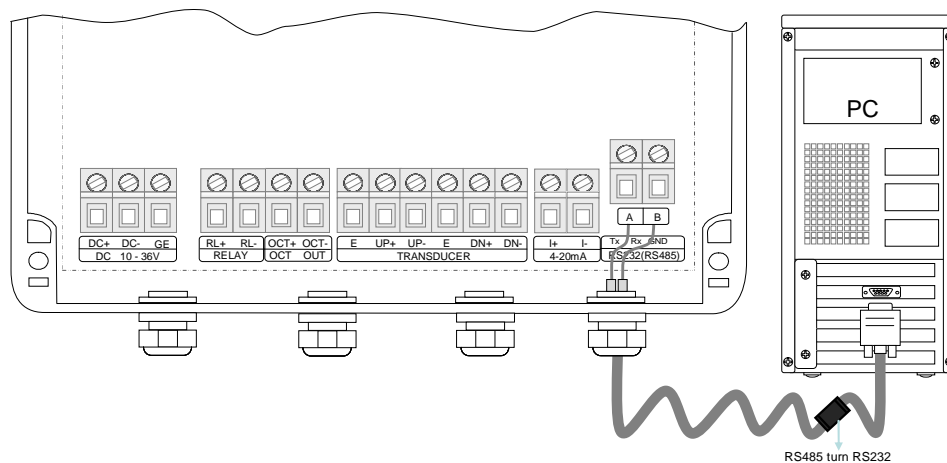

Drawing of Upper Computer RS-485 network data acquisition system

Notices:

When the flowmeter is in flowmeter network ,the following network IDN:13(0DH ENTER), 10(0AH NEWLINE), 42(2AH*) and 38(26H&). The Network IDN is set in M46.

9.3 Communication protocol and the use

The communication protocol format used by the ultrasonic flowmeter is an expanded set of the Fuji FLV series flowmeter protocol. The host device requests the flowmeter to answer by sending a "command". The baud rate of asynchronous communication (Primary station; computer system; ultrasonic flowmeter) is generally 9600BPS. A single byte data format (10 bits): one start bit, one stop bit and 8 data bits. Check bit: NONE.

9.3.1 FUJI Protocol

The communication protocol format used by the ultrasonic flowmeter is an expanded set of the Fuji FLV series flowmeter protocol. The host device requests the flowmeter to answer by sending a "command". The baud rate of asynchronous communication (Primary station: computer system; Secondary station: ultrasonic flowmeter) is generally 9600BPS. A single byte data format (10 bits): one start bit, one stop bit and 8 data bits. Check bit: NONE.

A data character string is used to express basic commands and a carriage return (ENTER) is used to express the end of a command. The characteristic is that the string of data is flexible. Frequently used commands are as follows:

Communications commands

Command	Description	Data Format
DQD(cr)(lf) *0	Return daily instantaneous flow	±d.dddddddE±dd(cr) *1
DQH(cr)(lf)	Return hourly instantaneous flow	±d.dddddddE±dd(cr)
DQM(cr) (lf)	Return instantaneous flow per minute	±d.dddddddE±dd(cr)
DQS(cr) (lf)	Return instantaneous flow per second	±d.dddddddE±dd(cr)
DV(cr) (lf)	Return instantaneous velocity	±d.dddddddE±dd(cr)
DI+(cr) (lf)	Return positive accumulative flow	± d d d d d d d d E ± d (cr) *2
DI-(cr) (lf)	Return negative accumulative flow	± d d d d d d d d E ± d (cr)
DIN(cr) (lf)	Return net accumulative flow	± d d d d d d d d E ± d (cr)
DID(cr) (lf)	Return identification code of instrument (address code)	d d d d d (cr) 5 bits in length
DL(cr) (lf)	Return signal intensity	UP:dd.d,DN:dd.d,Q=dd(cr)
DC(cr) (lf)	Return current error code	*3
DT(cr) (lf)	Current date and time	yy-mm-dd,hh:mm:ss(cr)
LCD(cr) (lf)	Return currently displayed content on LCD display	
ESN(cr) (lf)	Return electronic serial number	d d d d d d d d (cr)(lf) *4
W	Networking command prefix of numeric string address	*5
P	Prefix of return command with check	
&	Function sign of command "add"	

*Note:

- (cr)expresses carriage return. Its ASCII value is 0DH. (lf) expresses line feed. Its ASCII value is 0AH.
- "d" expresses 0-9 number. 0 value is expressed as +0.000000E+00.
- "d" expresses 0-9 numbers. There is no decimal point in integral part before "E".
- The status of the machine is expressed by 1-6 letters. See the error code section for the meaning of the characters. For example, "R" and "IH".
- Eight " d d d d d d d d " expresses the electronic serial number of the machine. "t" expresses the type of machine.
- If there are multiple flowmeters in a data network then the basic commands cannot be used alone. The prefix W must be added. Otherwise, multiple flowmeters will answer simultaneously, which will cause chaos in the system.

Function prefix and function sign

Prefix P

The character P can be added before every basic command. It means that the transferred data has CRC verification. The method of counting the verified sum is achieved by binary system addition.

For example: Command DI+(CR) (the relative binary system data is 44H, 49H, 2BH, 0DH) transferred data is +1234567E+0m3. (CR) (the relative binary system data is 2BH, 31H, 32H, 33H, 34H, 35H, 36H, 37H, 45H, 2BH, 30H, 6DH, 33H, 20H, 0DH, 0AH). And command PDI+ (CR) transferred data is +1234567E+0m3! F7 (CR), "!" means the character before it is the sum character, and the verified sum of the two bytes after it is (2BH+31H+32H+33H+34H+35H+ 36H+37H+45H+2BH+30H+6DH+33H+20H =(2)F7H)

Note: there can be no data before "!", and also may be a blank character.

Prefix W

Usage of prefix W: W+ numeric string address code +basic command. Value range of the numeric string is 0~65535, except 13 (0DH carriage return), 10 (0AH line feed), 42 (2AH *) and 38 (26H &). If the instantaneous velocity of No. 12345 flowmeter is to be accessed, the command W12345DV(CR) can be issued. Corresponding binary code is 57H, 31H, 32H, 33H, 34H, 35H, 44H, 56H and 0DH

Function sign &

Function sign & can add up to 5 basic commands (Prefix P is allowed) together to form a compound command sent to the flowmeter together. The flowmeter will answer simultaneously. For example, if No. 4321 flowmeter is requested to simultaneously return: 1] instantaneous flow, 2] instantaneous flow velocity, 3] positive total flow, 4] energy total, 5] AI1 analogous input current value, the following command is issued:

W04321PDQD&PDV&PDI+&PDI-&PDIN(CR)

Simultaneously returned data are likely as follows:

+0.000000E+00m3/d! AC(CR)

+0.000000E+00m/s! 88(CR)

+1234567E+0m3! F7(CR)

+0.000000E+0m3! DA(CR)

+0.000000E+0 m3! DA(CR)

9.3.2 MODBUS Communication Protocol

This MODBUS Protocol uses RTU transmission mode. The Verification Code uses CRC-16-IBM (polynomial is $X^{16}+X^{15}+X^2+1$, shield character is 0xA001) which is gained by the cyclic redundancy algorithm method.

MODBUS RTU mode uses hexadecimals to transmit data.

This MODBUS-I Protocol uses RTU transmission mode. The Verification Code uses CRC-16-IBM (polynomial is $X^{16}+X^{15}+X^2+1$, shield character is 0xA001) which is gained by the cyclic redundancy algorithm method.

MODBUS-I RTU mode uses hexadecimals to transmit data.

9.3.2.1 MODBUS Protocol Function Code and Format

The flow meter protocol supports the following two-function codes of the MODBUS:

Function Code	Performance Data
0x03	Read register
0x06	Write single register

9.3.2.2 MODBUS Protocol function code 0x03 usage

The host sends out the read register information frame format:

Slave Address	Operation Function Code	First Address Register	Register Number	Verify Code
1 byte	1 byte	2 bytes	2 bytes	2 bytes
0x01~0xF7	0x03	0x0000~0xFFFF	0x0000~0x7D	CRC(Verify)

The slave returns the data frame format:

Slave Address	Read Operation Function Code	Number of Data Bytes	Data Bytes	Verify Code
1 byte	1 byte	1 byte	N*x2 byte	2 bytes
0x01~0xF7	0x03	2xN*	N*x2	CRC(Verify)

N* = data register number

The range of flow meter addresses 1 to 247 (Hexadecimal: 0x01~0xF7), and can be checked in the Menu 46. For example, decimal number "11" displayed on Menu 46 means the address of the flow meter in the MODBUS protocol is 0x0B.

The CRC Verify Code adopts CRC-16-IBM (polynomial is $X^{16}+X^{15}+X^2+1$, shield character is 0xA001) which is gained by the cyclic redundancy algorithm method. Low byte of the verify code is at the beginning while the high byte is at the end.

For example, to read the address 1 (0x01) in the RTU mode, if the instantaneous flow rate uses hour as a unit(m³/h), namely reads 40005 and 40006 registers data, the read command is as follows:

```

0x01          0x03          0x00 0x04          0x00 0x02          0x85 0xCA
Flowmeter Address  Function Code  Register Address  Register Number  CRC Verify Code

```

Flowmeter returned data is (assuming the current flow=1.234567m³/h)

```

0x01          0x03          0x04          0x06 0x51 0x3F 0x9E          0x3B 0x32
Flowmeter Address  Function Code  Data Bytes  Data(1.2345678)  CRCVerify Code

```

The four bytes 3F 9E 06 51 is in the IEEE754 format single precision floating point form of 1.2345678.

Pay attention to the data storage order of the above example. Using C language to explain the data, pointers can be used directly to input the required data in the corresponding variable address, the low byte will be put at the beginning, such as the above example 1.2345678 m/s, 3F 9E 06 51 data stored in order as 06 51 3F 9E .

9.3.2.3 Error Check

The flowmeter only returns one error code 0x02 which means data first address in error.

For example, to read address 1 (0x01) of the flowmeter 40002 register data in the RTU mode, the flowmeter considers it to be invalid data, and sends the following command:

```

0x01          0x03          0x00 0x01          0x00 0x01          0xD5 0xCA
Flowmeter Address  Function Code  Register Address  Register Number  CRC Verify Code

```

Flowmeter returned error code:

```

0x01          0x83          0x02          0xC0 0xF1
Flowmeter Address  Error Code  Error Extended Code  CRC Verify Code

```

9.3.2.4 MODBUS Register Address List

The flowmeter MODBUS Register has a read register and a single write register.

Read Register Address List (use 0x03 performance code to read)

PDU Address	Register	Data description	Type	No. registers*	Remark
\$0000	40001	Flow/s - low word	32 bits real	2	
\$0001	40002	Flow/s - high word			
\$0002	40003	Flow/m - low word	32 bits real	2	
\$0003	40004	Flow/m- high word			
\$0004	40005	Flow/h - low word	32 bits real	2	
\$0005	40006	Flow/h - high word			
\$0006	40007	Velocity – low word	32 bits real	2	
\$0007	40008	Velocity – high word			
\$0008	40009	Positive total – low word	32 bits int.	2	
\$0009	40010	Positive total – high word			
\$000A	40011	Positive total – exponent	16 bits int.	1	
\$000B	40012	Negative total—low word	32 bits int.	2	
\$000C	40013	Negative total—high word			
\$000D	40014	Negative total—exponent	16 bits int.	1	
\$000E	40015	Net total—low word	32 bits int.	2	
\$000F	40016	Net total—high word			
\$0010	40017	Net total—exponent	16 bits int.	1	
\$0016	40023	Up signal int – low word	32 bits real	2	0~99.9
\$0017	40024	Up signal int – high word			
\$0018	40025	Down signal int – low word	32 bits real	2	0~99.9
\$0019	40026	Down signal int – high word			
\$001A	40027	Quality	16 bits int.	1	0~99
\$001B	40028	4~20mA Analog output—low word	32 bits real	2	Unit: mA

\$001C	40029	4~20mA Analog output – high word			
\$001D	40030	Error code – char 1,2	String	3	Refer to "Error Analysis" for detailed codes meanings.
\$001E	40031	Error code – char 3,4			
\$001F	40032	Error code – char 5,6			
\$003B	40060	Velocity unit – char 1,2	String	2	Currently support m/s only
\$003C	40061	Velocity unit – char 3,4			
\$003D	40062	Flow unit – char 1,2	String	2	
\$003E	40063	Flow unit – char 3,4			
\$003F	40064	Total unit – char 1,2	String	1	

Notes:

- The following flow rate units are available:

0. "m3" –Cubic Meter	5. "cf" –Cubic Feet
1. "l" –Liters	6. "ba" –US Barrels
2. "ga" –Gallons	7. "ib" –Imperial Barrels
3. "ig" –Imperial Gallons	8. "ob" –Oil Barrels
4. "mg" –Million Gallons	
- When the flowmeter address or communication baud rate change, the meter will work under the new address or communication baud rate after the communication baud rate responded with returned primary address and communication baud rate.
- 16 bits int – short integer, 32 bits int – long integer, 32 bits real – floating point number, String – alphabetic string.

10 Appendix2-W211 Insertion Transducer

10.1 Overview

W211 type insertion transducers can be installed into metal pipelines via an isolation ball valve (installation into pipelines of plastic or other materials may require an optional mounting seat). The maximum pipe diameter in which insertion transducers can be installed is DN2000. Fluid temperature range: $-10^{\circ}\text{C} \sim +80^{\circ}\text{C}$. Sensor cable length (9m standard) normally can be extended to as long as 100m.

Figure 1 shows a diagram of the W211 Insertion Transducer. The insertion transducer is attached to its mounting base (which is welded to the pipe section at the measurement point) via a ball valve. When the transducer is removed, pipe fluids can be contained by shutting off the ball valve. Therefore, installation and extraction of the transducer can be performed without relieving pipeline pressure. An O-ring seal and joint nut guarantee user safety while installing or operating the transducer.

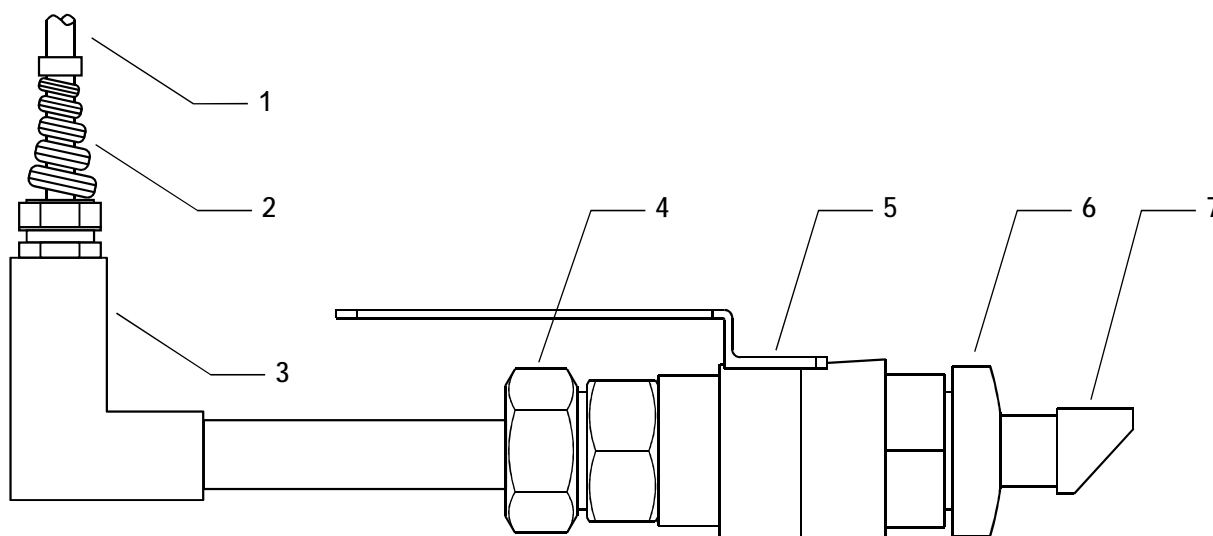

Construction Drawing of W211 Insertion Transducer

- | | | |
|--------------------|------------------|---------------------|
| 1. Cable | 4. Lock - nut | 7. Transducer probe |
| 2. Cable Connector | 5. Ball valve | |
| 3. Connector | 6. Mounting base | |

10.2 Measurement Point Selection

To obtain the strongest signal strength and the highly accurate measurement results, it is necessary to select an appropriate measurement point before installing the transducer. For examples of measuring point selection, see the related section in the manual.

10.3 Determining Transducer Spacing & Transducer Installation

The mounting space of insertion transducer is the center-to-center hole distance between the two transducers (please refer to Menu 25). After entering the right parameter, please check the mounting space in Menu 25. (unit: mm)

Mounting method:

1. Drilling at the measuring point, the diameter of the drilling hole is 24mm. Before drilling, please make the hole center of transducer mounting base aim at the drilling hole center, and then weld it on the pipe vertically. (When the flowmeter need to be hot-tapped into the pipe under pressure without flow interruption ,please refer to the pFlow's operation construction of DDK electric Hot-tapping or corresponding equipment.)
2. Close the ball valve and screw it tightly on the mounting base.

3. Twist off the locknut and loose the lock ring, pull the transducer into the joint nut, and then screw up the joint nut on the ball valve.
4. Open the ball valve and insert the transducer, measure the dimension from the outer surface of the pipe to the front end surface of handspike position to meet the following formula:

$$H = 175 - d$$

In this formula:

- H is Mounting height (mm);
- 175 is Transducer length (mm);
- d is Pipe wall thickness (mm).

5. Tighten the nut slightly, make the locking ring press the transducer, rotate the connector, make the installation direction of the connector consistent with the pipe axis and outward, and finally tighten the nut.
6. Connect the transducer cables to the corresponding upstream / downstream (upstream = red, downstream = blue) terminal ends.
7. Please refer to the following installation diagram(vertical view):

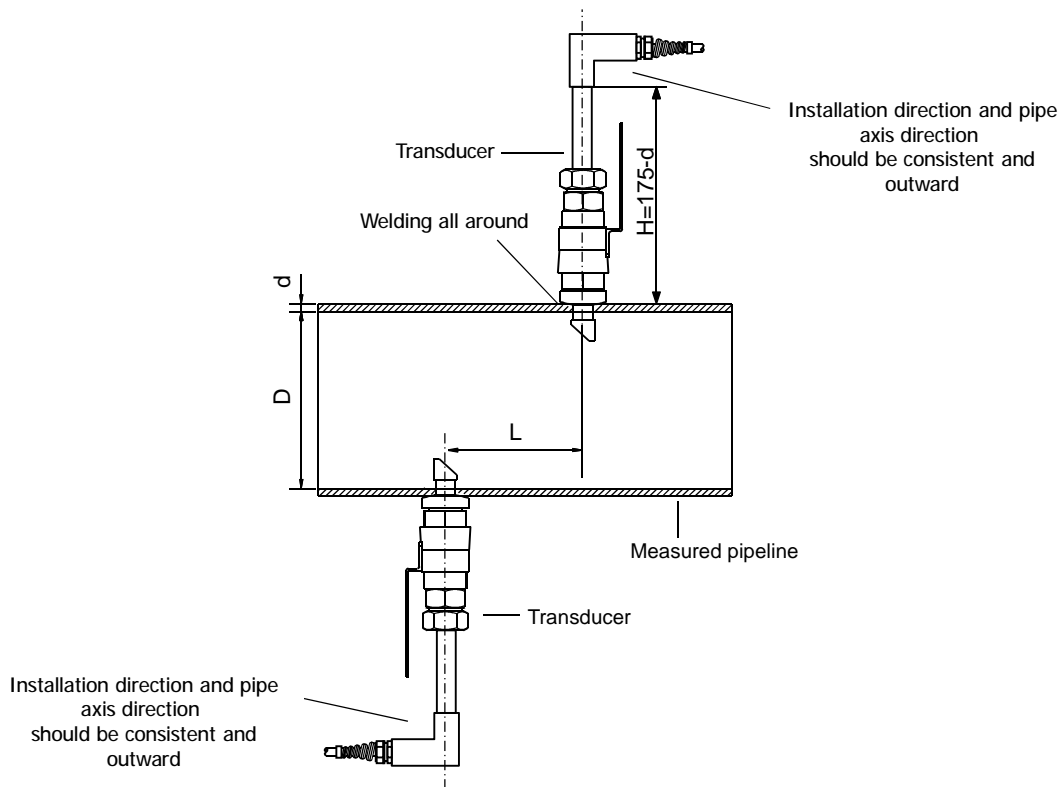

Important



The direction of the connector shall be consistent with the center line of the pipeline under test and outward, otherwise the sensor will not receive the signal.

On the horizontal measuring pipeline, the sensor must be installed in the positive side position (i.e. 3 o'clock, 9 o'clock position), because there are often bubbles or air pockets in the upper part of the pipeline, and sediment at the bottom, which causes signal attenuation.

10.4 Transducer Mounting Methods

W211 insertion transducer mounting method: Z method through M24, it should be installed according to the specific application condition.

10.4.1 Z Mounting Method

Z method is the most commonly used mounting method for insertion-type ultrasonic Energy Meters, suitable for pipe diameters ranging from 50mm to 1200mm. Due to strong signal strength and high measurement accuracy, the Z method is preferable for pipe sections severely rusted or with too much scale formation on the inside wall. When installing the transducer using the Z method, be sure that the two transducers and the pipeline center axis are in the same plane, but never in the 6 or 12 o'clock positions. see below:

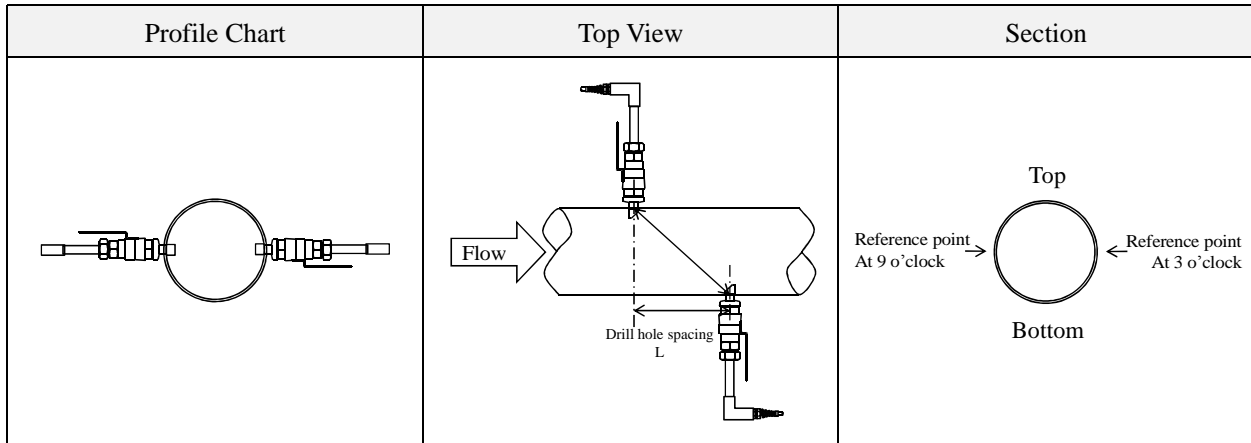

10.4.2 Pipe Parameter Entry Shortcuts

For example, measuring the diameter of DN200, pipe outside diameter is 219mm, pipe wall thickness is 6mm, pipe inner diameter is 207mm, measuring medium is water, and material is carbon steel, no liner, can be operated as follows:

Step1. Pipe outside diameter:

Press **Menu** **1** **1** keys to enter the window M11 and enter the pipe outside diameter, and then press the **Enter** key to confirm.

Pipe Outer Diameter
207.00 mm

(For insertion transducer, M11 menu need to be entered the pipe inner diameter)

Step2. Pipe wall thickness

Press the **Menu** **1** **2** key to enter the window M12, and enter the pipe wall thickness, and press the **Enter** key to confirm.

Pipe Wall Thickness
0.01 mm

(The Wall Thickness needs to be 0.01mm for use with insertion sensors.)

Step3. Pipe Material

Press the **Menu** **1** **4** keys to enter the window M14, press the **Enter** key, press the **^** or **v** key to select Pipe Material, and press the **Enter** key to confirm.

Pipe Material [14]
0. Carbon Steel

Step4. Transducers type(Note: display option error)

Press the **Menu** **2** **3** keys to enter the window M23, press the **^** or **v** key to select transducer type, and press the **Enter** key to confirm.

2. Plug—in-W211 (W type insertion transducer).

Transducer Type [23
2. Plug-in-W211

Step5. Transducer mounting methods

Press the **Menu** **2** **4** keys to enter the window M24, press the **Enter** key, press the **^** or **v** key to select transducer-mounting method, and press the **Enter** key to confirm.

Choose according to the pipes on site.

Transducer Mounting
1. Z

Step6. Adjust Transducer spacing

Press the **Menu** **2** **5** keys to enter the window M25, accurately install the transducer according to the displayed transducer mounting spacing and the selected mounting method (Refer to Installing the Transducers in this chapter).

Transducer Spacing
192.68 mm

Step7. Display measurement result

Press the **Menu** **0** **1** keys to enter the window M01.

Flow 0.1129m³/h *R
Vel 1.0415m/s

About other setup, please refer to the related information in the manual.